

SPECIFICATION



110t



56m



74.5m

SRC1100T

SANY ROUGH TERRAIN CRANE

QUALITY CHANGES THE WORLD

www.sanyglobal.com

It is one of the core business units in SANY Group, specializing in the development and manufacturing of high-end wheel cranes, crawler cranes and tower cranes, including the complete range of wheel cranes from 8 to 2400t, crawler cranes from 25 to 4500t and tower cranes from 6 to 185t.

三一集团旗下核心事业部，从事高端轮式起重机、履带起重机、塔式起重机系列产品的研发制造。覆盖8-2400吨全吨位轮式起重机，25-4500吨全吨位履带起重机，6-185吨塔式起重机。



SANY CRANE



SRC1100T

SANY ROUGH TERRAIN CRANE
110T LIFTING CAPACITY

An 110t rough terrain crane with 6 section 56m boom, featuring stronger lifting capacity. Key components come from name brands of reliable quality. Operator comfort is improved by brand new cab design.

一款最大起重量110吨，6节臂，全伸臂长56m的越野起重机，性能强，核心部件均为国际知名供应商提供，配备全新操纵室，驾驶、操作舒适度全面升级。





Strong lifting capacity

Best in class

超强性能

性能超越行业同吨位

All new operator's cab

Ergonomic concept of safety and comfort

全新操纵室

操作安全、舒适、人机工程全面升级

Convenient transport

One-trailer transport at low operational cost

超便捷运输

一车整运，运营成本低

Brand-name components

DF Cummins engine/Dana transmission

国际知名供应商

东风康明斯发动机/德纳变速箱



All New Operator's Cab

全新操纵室

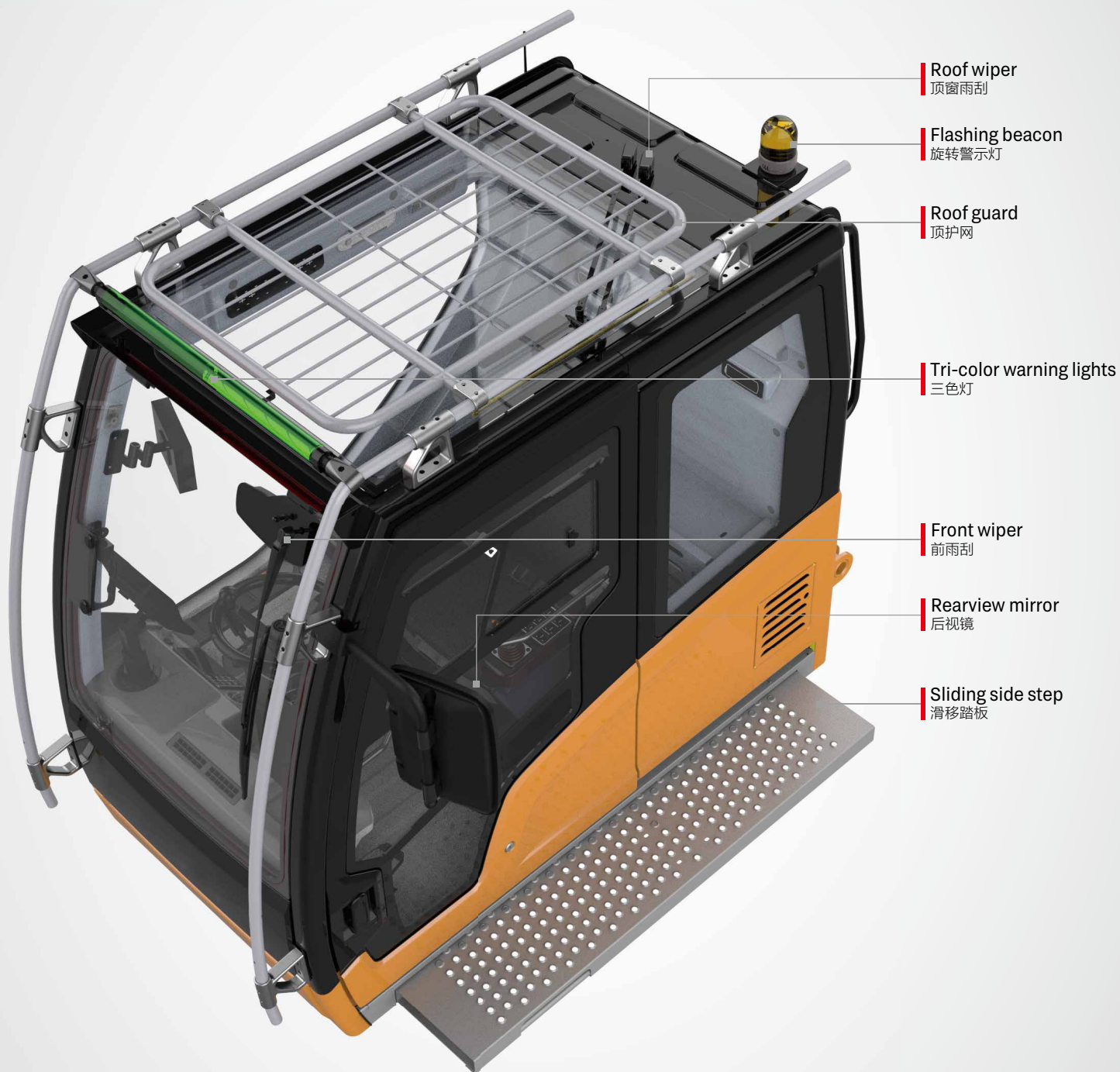

Roof wiper
顶窗雨刮

Flashing beacon
旋转警示灯

Roof guard
顶护网

Tri-color warning lights
三色灯

Front wiper
前雨刮

Rearview mirror
后视镜

Sliding side step
滑移踏板



Safety & Reliability
安全可靠



Comfort & Convenience
舒适便捷



Simplicity & Efficiency
简单高效

SPECIFICATION

Rearview and
winch monitor
卷扬监视器

10.1 inch LMI screen
10.1 吋显示屏

Outrigger control
panel
支腿控制面板

Steering column
方向柱

Pedals
踏板布置

Upper control panel
辅助面板

Emergency stop
switch
急停开关

Bubble level
水平仪

Cup holder
水杯托

Joystick
手柄

Joystick
手柄

Left control panel
左扶手箱控制面板

Right control panel &
LMI navigation knob
右扶手箱控制面板

Armrest
扶手箱

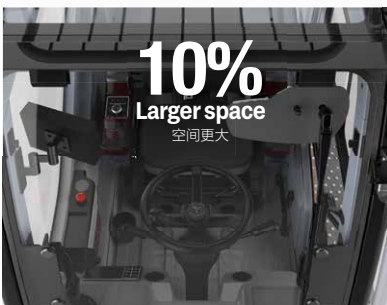
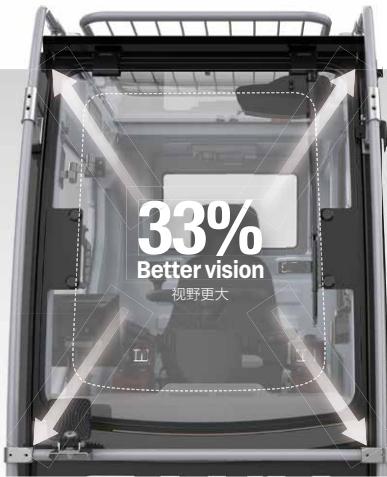

Integrating SUV genes, overall space is enlarged by 10% and forward field of vision is increased by 33%. The front windshield can be opened by 70 degrees, providing better ventilation and a second emergency exit.

融入 SUV 基因, 整体空间增大 10%, 配备超大可开合 70° 前挡风玻璃, 视野提升 33%, 增加空气对流, 并可作为快速逃生通道。



Sliding door transits between tracks when closing to make perfect thermal and acoustical insulation.

侧向变轨滑移门完美隔绝外部环境。

Getting in and out is made more convenient with the power sliding side step.

全宽电动伸缩踏板, 超大安全便利进出通道。

SPECIFICATION

Adjustable steering wheel for driving and controlling, modular control panels, and smart user interface deliver intuitive and highly efficient control.

驾控一体的方向盘、模块化控制面板、UI 智能操作界面，操作简单，为高效吊装保驾护航。



Convenient Transport

行驶运输便捷性

Four Steering Modes

四种转向模型

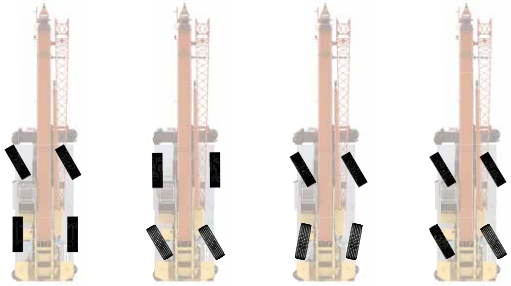

2 wheel front 前轮转向模式

2 wheel rear 后轮转向模式

4 wheel 四轮转向模式

Crab 蟹行模式



Steering control panel
转向控制面板

One-trailer Transport

一车整运

The basic machine is transported with counterweight, jib, and hooks onboard at 55t, 3.34m wide and 3.93m high, satisfying road regulations.

主机运输尺寸为宽 3.34m, 高 3.93m, 重量为 55t (带配重、副臂和吊钩), 满足道路运输要求。



Axle Load Distribution

轴荷分布

Items 项目	Weight (kg) 重量	Load on front axle (kg) 前轴轴荷	Load on rear axle (kg) 后轴轴荷
Basic machine 主机	55000	30000	25000
Counterweight 配重	10600	-4000	14600
Fixed jib 副臂	1100	2600	-1500
Aux. boom nose 臂尖滑轮	50	160	-110
Main hook 主钩	100t	1030	-1300
	90t	830	-1050
	70t	690	-870
	50t	595	-760
Auxiliary hook 副钩	8t	160	-40

Note: boom angle remains 0°
起重臂角度 0°

Carrier Frame

车架底盘



Inverted trapezoidal variable cross section frame is 5% less in weight and 10% stronger in rigidity.

倒梯形变截面车架, 实现车架减重 5% 的同时, 刚性提升 10%。

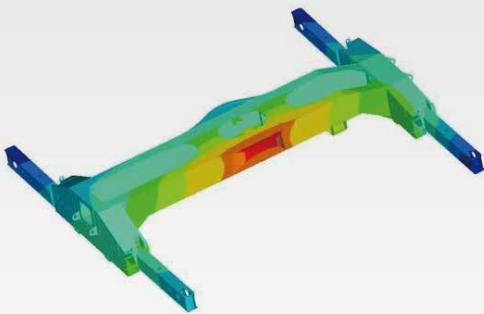

↓ 5%
Weight 重量

↑ 10%
Rigidity 刚性

Power Train

动力系统

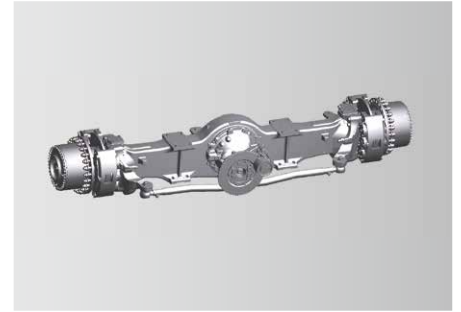
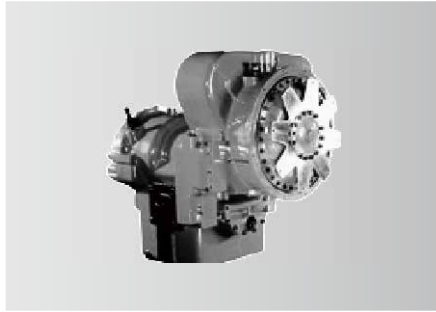
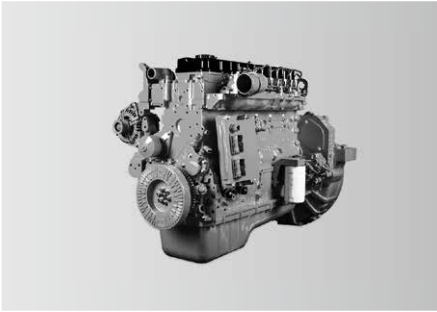

Engine

Power comes from a DF Cummins QSB6.7 inline six-cylinder water-cooled, turbocharged and intercooled off-highway diesel engine, complying with Stage III emission standard.
Rated power: 194kW/2400rpm.
Max. torque: 990N·m/1500rpm.

发动机

东风康明斯 QSB6.7 三阶段非道路直列六缸水冷、增压中冷柴油发动机。
额定功率 :194kW/2400rpm。
最大扭矩 :990N·m/1500rpm。

Transmission

Dana electronically controlled auto transmission features 6 speeds forward and 6 speeds reverse, wide ratio range, and smooth gearshift with reduced maintenance cost.

变速箱

德纳全自动电控变速箱, 6个前进挡、6个后退挡, 速比范围大, 换挡平顺无冲击, 维修保养成本低。

Axle and suspension

Both axles are driven and steered. Front axle is mounted to the frame by independent steel plate, and rear adopts oscillation cylinders with hydraulic lockout. Driving comfort and lateral stability is therefore guaranteed on rough terrains and conditions.

车桥悬挂

前后桥均为驱动桥和转向桥。前桥采用独立式钢板连接, 后桥采用摆动支架式, 液压油缸闭锁悬架系统; 能适用各种恶劣工况和路面, 保证车辆行驶的平顺性和侧翻稳定性, 驾驶舒适。

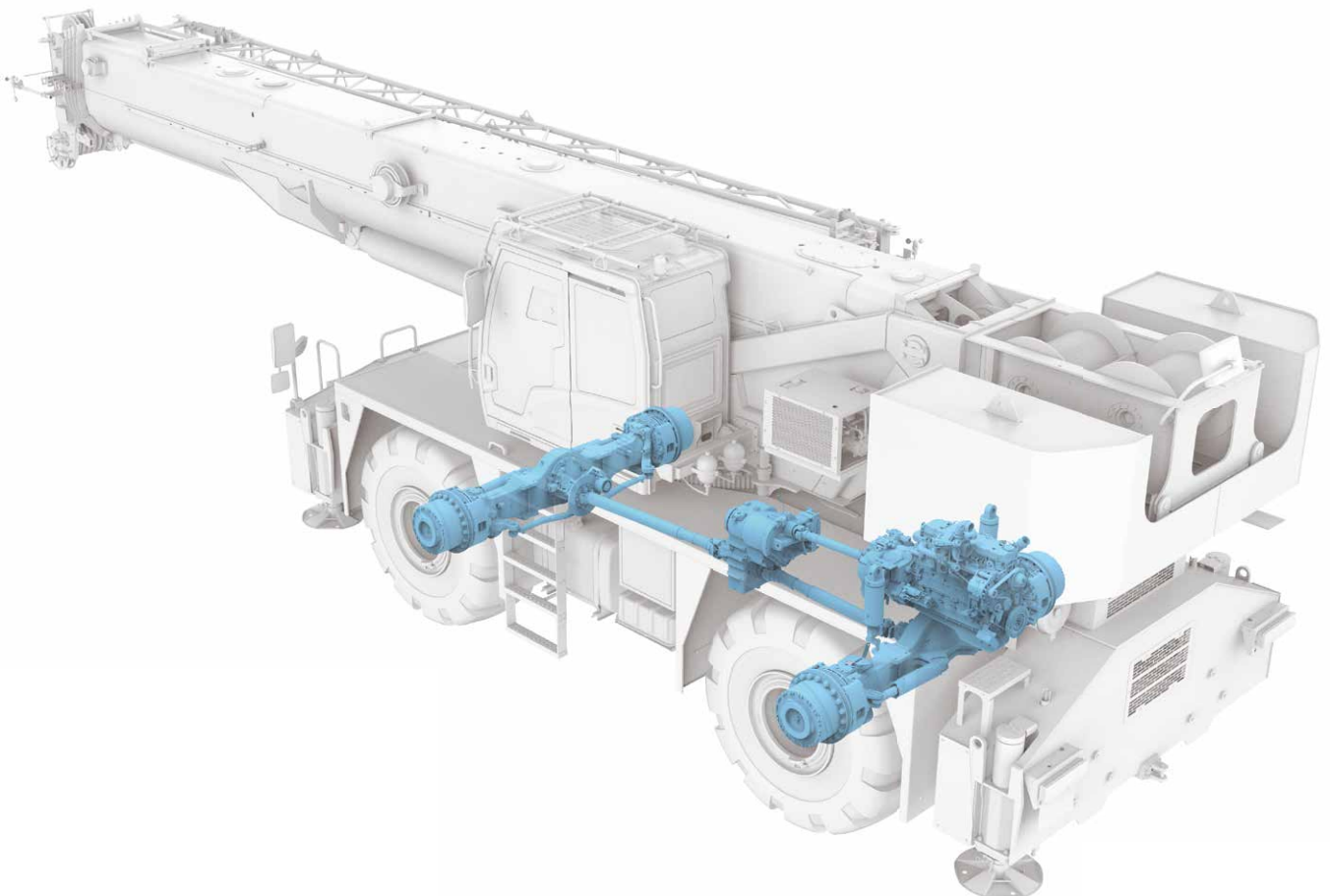

Electrical System

电气系统

Smart CAN-BUS communication system

International advanced CAN-BUS data communication network applied for display, instrument panel, I/O module, joysticks and main sensors, allowing for high-speed data transmission and quick response in less than 20ms.

Winch camera (optional)

Winch cameras equipped for monitoring its working condition and identifying rope disorder in time.

Integrated bus button panel input

Various operating states displayed by button indicator lights, and one-button multi-functional operation realizable by writing various operation modes.

智能总线通信系统

国际先进的分布式集成总线数据通信网络，显示器、显示仪表、I/O 模块、操作手柄、主要传感器等采用 CAN 总线组网，高速信息传输、响应速度小于 20ms。

卷扬监控系统(选配)

卷扬摄像头监视卷扬工作及及时发现乱绳的情况。

集成总线按键面板输入

可通过按键指示灯显示各种工作状态，通过写入多种操作模式实现一键多功能。



Centralized electric cabinet
集中式电控箱



Anti-two-block switch
高度限位器



Third wrap indicator
三圈保护器



Cable reel
电缆卷筒



Anemometer
风速仪

Multi-functional screen

Large 10.1 inch HD touch screen display with all new interface. Incorporated crane setup, load charts, working conditions, working period, virtual wall, Bluetooth, radio and diagnostics with an additional navigation knob.

Precise load moment indicator

SANY independently developed LMI, accuracy of 0 ~ 5%.

高新多功能显示屏

采用 10.1 寸高清显示屏, 全新操作界面, 可实现触摸与旋钮多种方式操控。工况、力矩、发动机、变速箱、控制器 IO 点、工作时间统计等丰富的设备状态信息呈现, 集成虚拟墙、蓝牙、收音机等多种扩展功能。

精准力 limiter 系统

三一自主研发的力矩限制器系统, 精度达 0~5%。



MachineLink⁺

ROOTCLOUD T-AMS Pro device comes as standard to realize GPS trajectory, machine status, maintenance management, E-fence, alarm management, and operator management on computer or mobile MachineLink+ platform, by remote control of cranes. This telematics package greatly boosts efficiency of customer fleet management and helps provide better after-sales services.

标配树根物联终端 T-AMS Pro, 通过对起重机设备的远程控制, 在电脑或移动端 MachineLink+ 平台实现轨迹回放、设备状态、维保设备、电子围栏、报警管理、操作手管理等功能, 极大提高客户设备管理效率, 提升三一售后服务能力。

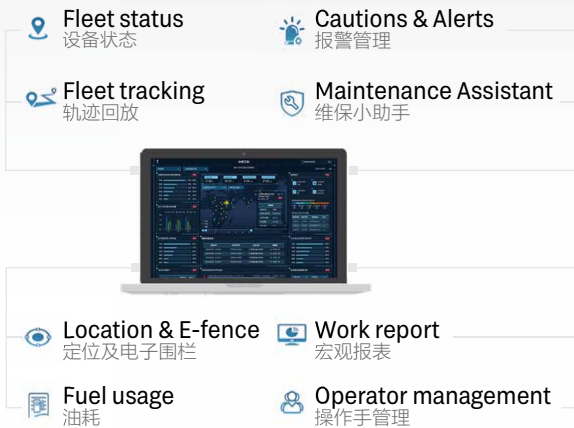

Hydraulic System

液压系统

Five boom sections independently extended by single cylinder pinning mechanism for variable length combinations..

6 节主臂, 大臂间彼此独立, 采用单缸插销伸缩机构, 臂长任意组合。

Superstructure

上车

Open-type electronically controlled load-sensing system and dynamic slewing brake system. Electro proportional compensated passive luffing-down system applied to control the luffing speed, making luffing more reliable and stable.

Dynamic slewing brake realizing precise control of slewing speed.

Electronically controlled load-sensing hydraulic system, electronic joystick and electronic throttle, ensuring easy operation and more accurate control and millisecond-level action response speed, with min. single-rope hoisting speed 0.8m/min, and distribution difference in case of combined motions 8%.

通过开式电控负载敏感系统和动态回转制动系统；

电比例自重落幅系统控制落幅速度, 更可靠更平稳；

具备动态回转制动功能, 可实现回转速度精准控制；

电控负载敏感液压系统, 采用电手柄、电油门控制, 轻松操作的同时, 控制更精准；动作响应毫秒级速度；卷扬单绳最低速度 0.8m/min；复合动作分配误差 8%。



Chassis

下车

Steering system

A gear pump installed to supply oil for hydraulic steering, steering pressure controlled by electro-proportional relief valve, four steering modes realized by solenoid directional valve.

Suspension system

Different modes including normal driving and Pick & Carry with suspension locked, suspension to be locked when the crane is working.

Outrigger telescoping system

The electro proportional relief valve identifies pressure staging of outrigger telescoping, satisfying operation requirements under high pressure and forming protection under limited pressure.

转向系统

液压转向系统采用齿轮泵提供油源,通过电比例溢流阀精确控制转向压力,通过电磁换向阀实现前轮转向,后轮转向,全轮转向和蟹行转向共计四种转向模式。

悬挂系统

悬挂系统通过选择不同的悬挂模式可以实现正常行驶和锁定模式下的带载行驶;在起重机上车作业时能够对悬挂进行锁定。

支腿伸缩系统

支腿伸缩采用电比例溢流阀对支腿伸缩进行压力分级,既满足高压动力动作需求,也可满足限压保护功能。

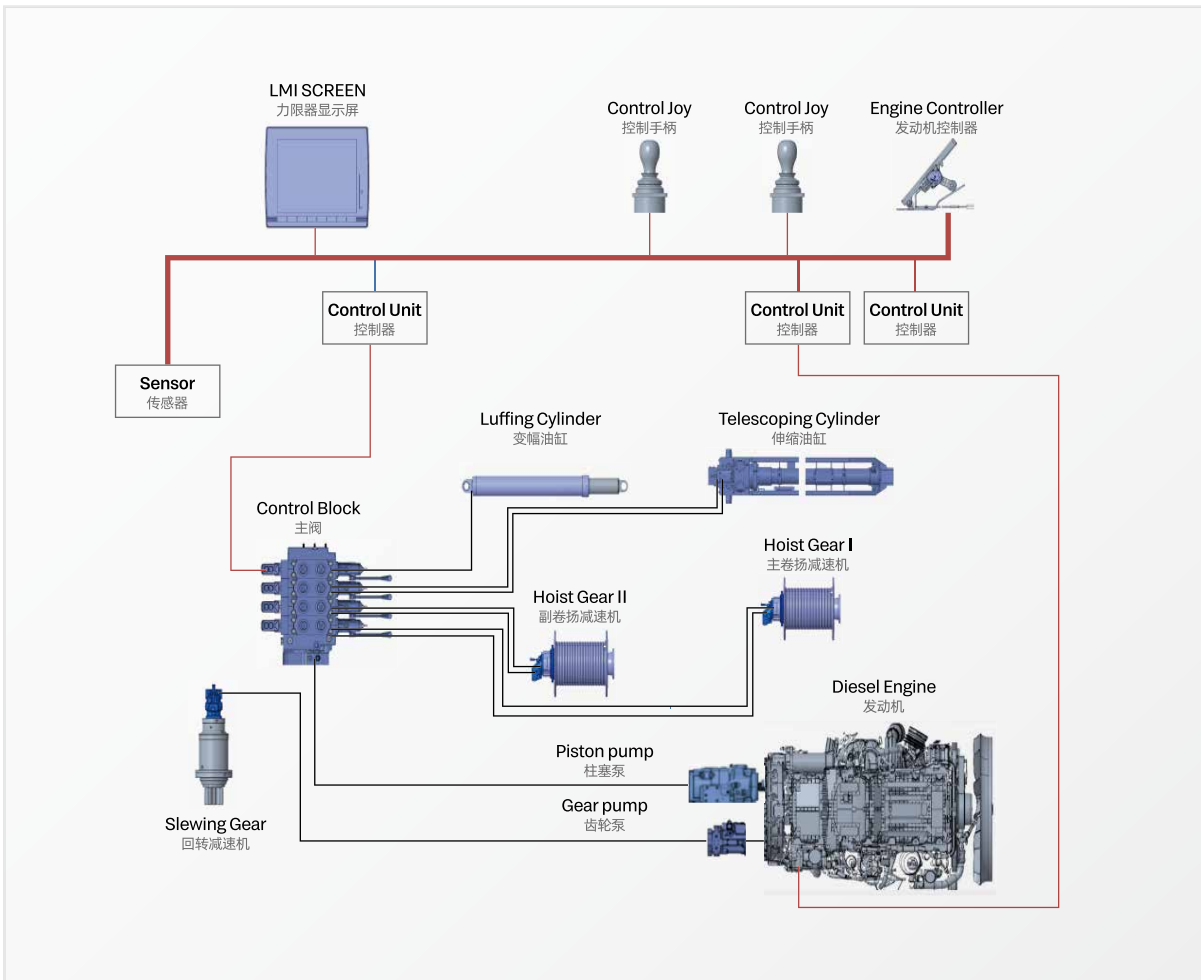

Overall Dimensions

整机尺寸

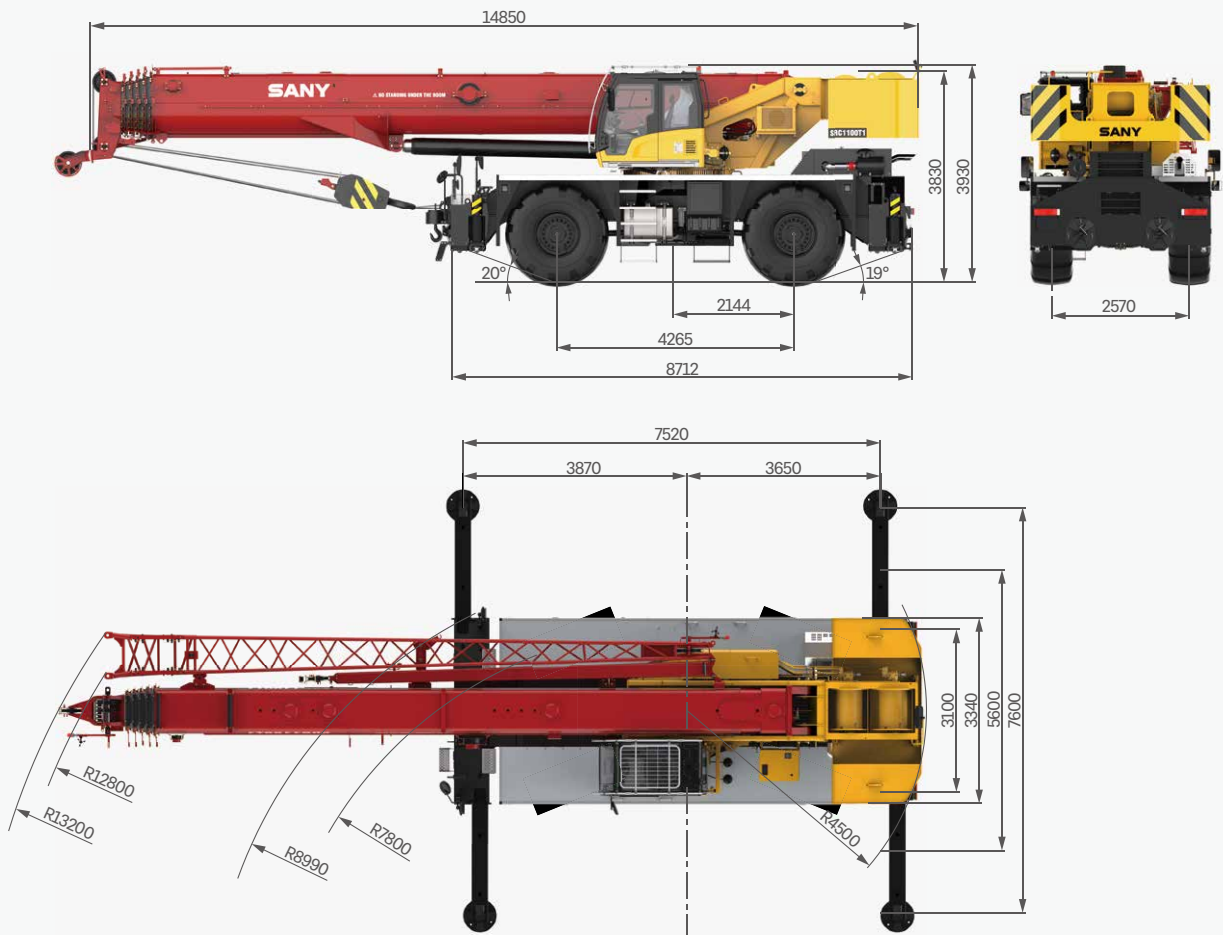

Technical Specification

整机参数

CATEGORY 类型	ITEM 项目	UNIT 单位	VALUE 参数	
CAPACITY 额定起重量	Max. lifting capacity 最大起重量	t	110	
WEIGHT 重量参数	Gross weight 整机总质量	kg	55000	
POWER 发动机参数	Engine model 发动机型号 (排放标准)	-	Cummins QSB6.7 (Tier III)	
	Max. engine power 发动机最大功率	kW/rpm	194/2400	
	Max. engine torque 发动机最大输出扭矩	N·m/rpm	990/1500	
DIMENSIONS 尺寸参数	Overall length 整机全长	mm	14850	
	Overall width 整机全宽	mm	3340	
	Overall height 整机全高	mm	3930	
TRAVEL 行驶参数	Max. travel speed 最高行驶速度	km/h	30	
	Steering radius 转弯半径	Min.steering radius 最小转弯半径	m	14.2/7.8
		Min.steering radius of boom tip 臂头最小转弯半径	m	13.2
	Wheel formula 车轮模式	-	4 × 4, 4 × 2	
	Min.ground clearance 最小离地间隙	mm	530	
	Approach angle 接近角	°	20	
	Departure angle 离去角	°	19	
	Max.gradeability 最大爬坡度	-	75%	
	Fuel consumption per 100km 每 100 公里油耗	L	120	
	MAIN PERFORMANCE 主要性能参数	Working temperature range 使用温度区间	°C	-30~+51
Min.rated lifting radius 最小额定幅度		m	2.5	
Tail slewing radius 转台尾部回转半径		mm	4.5	
Boom sections (Qty.) 臂节数		-	6	
Boom shape 臂形状		-	U shape U 型	
Max.lifting moment 最大起重力矩		Basic boom 基本臂	kN·m	3057
		Full-extension boom 全伸主臂	kN·m	1393
		Full-extension boom + jib 全伸主臂 + 副臂	kN·m	1195
Boom length 臂长		Basic boom 基本臂	m	12.5
		Full-extension boom 全伸主臂	m	56
		Full-extension boom + jib 全伸主臂 + 副臂	m	74
Max.lifting height 最大起重高度		Basic boom 基本臂	m	13.5
		Full-extension boom 全伸主臂	m	56.5
		Full-extension boom + jib 全伸主臂 + 副臂	m	74.5
Outrigger span (Longitudinal × Transverse) 支腿跨距 (纵 × 横)	m	7.52 × 7.6		
Jib offset 副臂安装角度	°	0, 20, 40		
AIRCONDITIONER 空调	In operator's cab 上车空调	-	Heating & Cooling 制冷、制热	

Technical Specification

整机参数



Hook 吊钩

Rated load 额载 /t	Number of sheaves 滑轮数量	Rope rate 倍率	Hook weight/kg 吊钩重量
100 ○	7	14	1030
90 ○	6	12	830
70 ●	5	10	690
50 ○	4	8	595
8 ●	-	1	160

● Standard 标配 ○ Optional 选配



Operations 主要动作参数

Item 项目	Max. single rope lifting speed (empty load) 单绳速度 (空载)	Rope diameter/length 钢丝绳直径 / 长度	Max. single line pull 最大单绳拉力
Main winch 主卷扬	150m/min	20mm/300m	8.3t
Auxiliary winch 副卷扬	150m/min	20mm/165m	8.3t
Slewing speed 回转速度	1.8r/min		
Full luffing up/down time of boom 主臂起落幅时间	70s/72s		
Full extension/retraction time of boom 主臂伸缩时间	350s/360s		
Outrigger jack 垂直支腿	Retraction 缩	32s	
	Extension 伸	30s	
Outrigger beam 水平支腿	Retraction 缩	15s	
	Extension 伸	23s	

Crane Introduction

整机介绍

Carrier 下车

Carrier frame 车架

- Double longitudinal beam construction welded by high strength steel plate, higher bearing capacity.
- 车架为高强度钢板焊接而成的双纵梁结构，承载能力强。

Engine 发动机

- Model: DF Cummins QSB6.7 inline six-cylinder diesel engine with watercooler and inter cooler.
- Rate power: 194kW/2400rpm.
- Emission standard: Tier III.
- Fuel reservoir capacity: 350L.
- 型号：东风康明斯 QSB6.7 直列六缸、水冷却、增压中冷、柴油发动机。
- 额定功率：194kW/2400rpm。
- 排放标准：符合 III 阶段。
- 油箱容积：350L。

Transmission 变速箱

- Auto-transmission, 6 forward gears and 6 reverse gears, large speed ratio range, adaptable to slope climbing and high-speed traveling.
- 自动变速箱，变速箱有 6 个前进档、6 个后退档，速比范围大，即可满足低速场地爬坡行驶又可满足高速行驶。

Axle 车桥

- Two axle chassis of flexible maneuverability, four-wheel drive, excellent dynamic performance.
- 操控灵活，底盘两桥设计，前、后桥驱动，动力性能好。

Suspension system 悬挂

- The front is rigidly mounted, and the rear axle adopts pivot oscillation suspension with hydraulic lockout.
- 前桥刚性连接，后桥带油缸锁定枢轴摆动悬挂。

Tires 轮胎

- Large diameter 34PR off-road 29.5-25 tires deliver large ground clearance and strong off-road agility.
- 大直径 34 层级越野轮胎，离地间距大，越野性能强，轮胎型号 29.5-25。

Braking 制动系统

- Dual circuit braking system. When one circuit fails, the other can still work normally, improving the safety and reliability of the braking system.
- 双回路制动系统，当某一回路出现故障时，另一回路仍能正常工作，提高制动系统的安全性和可靠性。

Hydraulics 液压系统

- Adopt stable and high-quality main oil pump, enhancing system reliability. Precise parameter matching contributes to superior controllability of the vehicle.
- 采用稳定、高品质的主油泵，系统可靠性高；通过精确的参数匹配，操控性能优越。

Outrigger 支腿

- H-type telescoping outrigger, 4-point support, with span (longitudinal × transverse) 7.52m × 7.6m.
- 采用 H 形伸缩支腿，4 点支撑，纵、横跨距 7.52m × 7.6m。

Control system 控制系统

- CAN-BUS: The bus instrument of integrated intelligent control electrical system can display driving parameters at any time, making driving easier. At the same time, engine failure prompt makes the maintenance and troubleshooting more convenient and faster.
- All-round safety protection, the main and auxiliary hoists are equipped with three-circle indicators and A2B switches to prevent over-hoist-down and over winding of the wire ropes.
- Load moment indicator: It adopts highly intelligent moment indicator system to fully protect lifting operation and ensure accuracy, stability and comfort.
- 总线仪表：采用集成一体智能控制电气系统的总线仪表，可随时掌控行驾参数，驾乘轻松；同时拥有发动机故障提示功能，维修排故方便、快捷。
- 全方位的安全保护系统，主、副卷扬配置三圈保护器和高度限位器，防止钢丝绳过放和过卷，防倾翻保护，极限角度保护。
- 力 limiter：采用高度智能力矩限制器系统，全方位保护吊载作业，确保操作精准、平稳、舒适。

Crane Introduction

整机介绍

superstructure 上车

Operator's cab 操纵室

- New generation T-series operator's cab features curved-rail sliding door, safety glass and corrosion resistant steel construction with softened interior trim. Large internal space with panoramic skylight, adjustable seat and other user-friendly design incl. A/C, electric wiper, making it more comfortable and easier to work. The LMI screen is equipped to realize the logic integration of the control console and the display, so that all working data can be seen at a glance.
- 全新一代 T 系列操纵室，带变轨滑移门，配备安全玻璃，耐腐蚀钢板，配置软化内饰、超大内部空间、可调式座椅等人性化设计，配有空调、电动雨刮器，操作更舒适、轻松；配置力矩限制器显示屏，实现主控台与操作显示系统有机结合，使吊装作业的全部工况数据一目了然。

Boom system 臂架系统

- Boom: Six-section, basic boom 12.5m, full-extension 56m, made of high-strength welded structural steel with U-shape cross-section.
- Jib: Two-section, 10.5m / 18m, offset at 0°, 20°, 40°.
- 主臂：六节臂，基本臂 12.5m，全伸臂 56m，由高强度焊接结构钢制成，U 形截面。
- 副臂：两节副臂，分别为 10.5m 和 18m，安装角度为 0°，20°，40°。

Slewing platform 转台结构

- SANY independently developed, made of fine grain high strength steel in optimized structure.
- 三一自主设计，结构更优化，由细晶粒高强度钢制成。

Hydraulics 液压系统

- Load sensing variable piston pump can adjust displacement in real time to achieve high precision flow control, greatly reducing energy loss.
- Winch adopts electronically controlled variable motor with high operation efficiency. Max. single rope speed of main and auxiliary winch is 150m/min.
- Slewing system integrating slewing buffer and free swing technology, start & brake process is smoother and the inching motion performance is ever better.
- 采用负载敏感变量柱塞泵，能实时调节油泵排量，实现高精度的流量控制，极大的降低能量损耗。
- 卷扬采用电控变量马达，作业效率高；主、副卷扬单绳速度最大达 150m/min。
- 回转系统带集成回转缓冲阀，具有自由滑转功能，回转启动和控制平稳，微动性卓越。

Hoist 起升机构

- Pump and motor double variable speed regulation, highly efficient and energy saving. Balance valve and unique anti-hook-slip technology are perfectly coupled to achieve smooth rise and fall of the load. Nonrotation high strength wire rope is used.
- 泵、马达双变量调速，高效节能。卷扬平衡阀与独特的防溜钩技术完美结合，重物起落平稳。配备防旋转高强度钢丝绳。

Luffing system 变幅系统

- Double acting single rod hydraulic cylinder with balance valve, luffing angle: -2°~ 80°. Passive luffing down.
- 双作用单活塞杆液压缸，带安全平衡阀，变幅角度：-2°~80°，采用自重落幅系统。

Slewing 回转系统

- 360° slewing in both directions, max. speed 1.8r/min, hydro speed control. The unique slewing balance design makes the braking smoother.
- 360° 转动，最大回转速度 1.8r/min。液控比例调速控制。独特的回转缓冲设计，制动更平稳。

Counterweight 配重

- Fixed block 10.6t.
- 固定配重 10.6t。

Safety equipment 安全装置

- Load moment indicator: Analytical mechanics is applied and moment limiter calculation system based on the hoisting mechanics model is established. Through online empty-load calibration, the rated accuracy can reach 0-5% to fully protect the hoisting operation. In case of overload, the system will automatically give an alarm to guarantee safety operation.
- The hydraulic system includes balance valve, relief valve, two-way holding valve, etc. to realize system stability and reliability.
- The main and auxiliary winches are equipped with third-wrap indicators to prevent over-hoist-down of the wire rope.
- Boom head and jib head are equipped with A2B switches to prevent the wire rope from over winding.
- The length & angle sensor and pressure sensor are equipped to signify working status in real time, automatically stopping hazardous actions with buzzer alarm.
- 力矩限制器：采用分析力学方法，建立了基于吊重力学模型的力矩限制器计算系统，通过在线空载标定，额定吊重精度达到 0-5%，全方位保护吊载作业；超载作业时，系统自动报警提示，为操纵作业提供安全保障。
- 液压系统配置平衡阀、溢流阀、双向液压锁等元件，实现液压系统稳定可靠。
- 主、副卷扬配置三圈保护器，防止钢丝绳过放。
- 主、副臂臂端配置高度限位器，防止钢丝绳过卷。
- 配置长度角度传感器、压力传感器，实时显示起重机作业状态，自动切断危险动作，蜂鸣报警。

Optional equipment at extra fees 选配

- Winch camera / Boom tip camera / Reversing camera / 100t hook block / 90t hook block / 50t hook block / Spark arrester / Air intake shutoff valve / Outrigger pads / Hydraulic cylinder for jib deployment / Kessler axles / other equipment available upon request.
- 卷扬监控 / 臂尖摄像头 / 倒车监控 / 100t 吊钩 / 90t 吊钩 / 50t 吊钩 / 火星灭火器 / 发动机进气关断阀 / 支腿垫板 / 副臂推拉油缸 / 凯斯兰车桥 / 其他选配视需求定。

Working Conditions

工况组合



Telescopic boom on outriggers
主臂、支腿吊载

Fixed jib on outriggers
固定副臂、支腿吊载

Telescopic boom on tires
主臂、轮胎吊载

Operating Range - Telescopic Boom

起升高度曲线 - 主臂

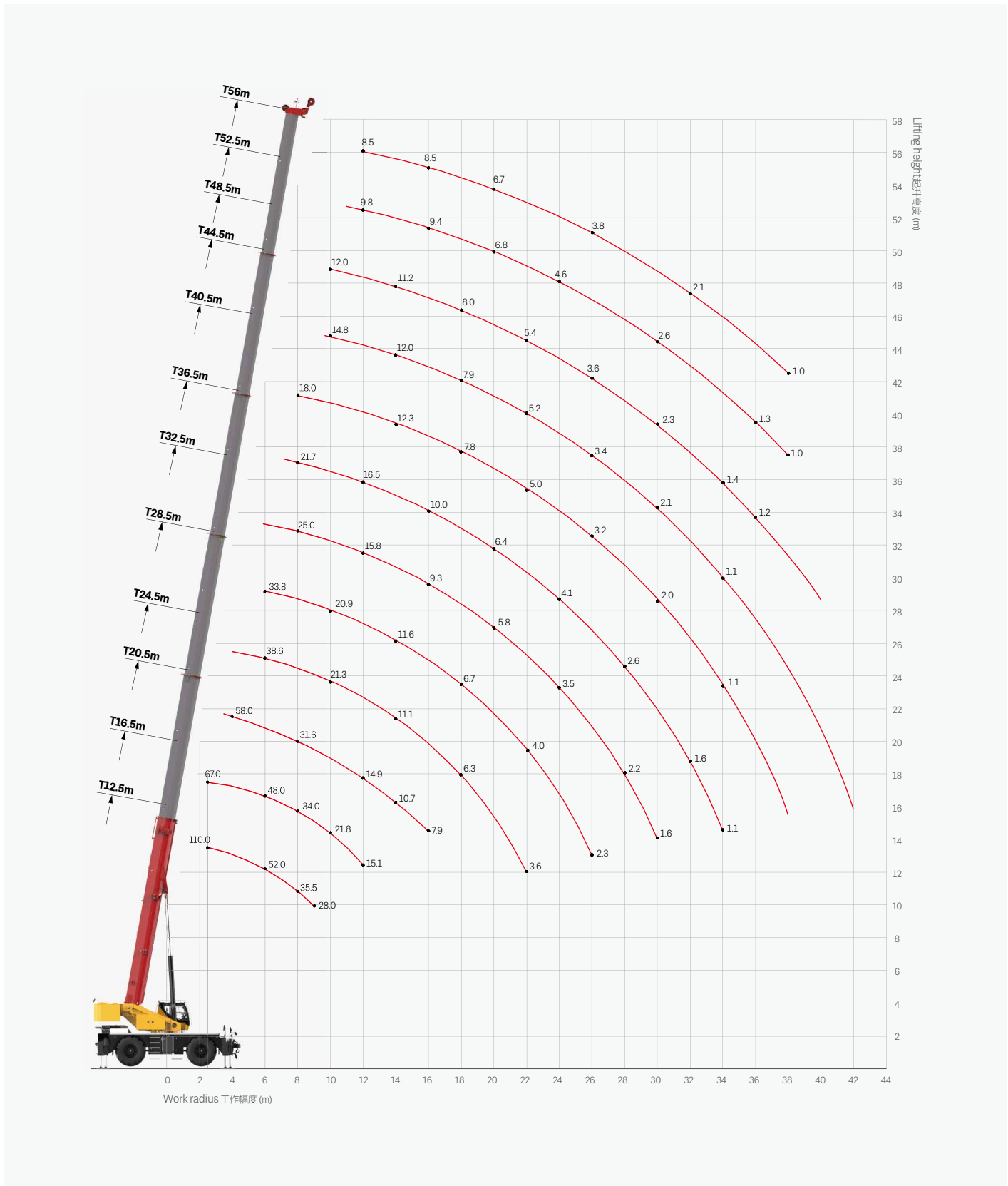





Load Chart-Telescopic Boom

性能表 - 主臂

Unit: kg



	12.5	16.5	16.5	20.5	20.5	20.5	20.5	24.5	24.5	24.5	24.5	28.5	28.5	28.5	32.5		
2.5	110000*	67000	36000													2.5	
3.0	90000	67000	36000	60000	51500	36000	29500									3.0	
3.5	78000	67000	36000	59000	51500	36000	27500	48000	46000	36000	29000					3.5	
4.0	71000	67000	36000	58000	51500	36000	25800	48000	46000	36000	27400					4.0	
4.5	65000	62500	33900	54500	51500	36000	24200	45700	46000	36000	26000	37600	33000	23000		4.5	
5.0	60000	57000	32300	51200	51500	34800	22800	43000	46000	36000	24600	36500	32900	22100		5.0	
5.5	55000	51700	30800	48600	49500	33400	21600	40800	46000	34800	23500	35200	32800	21100		5.5	
6.0	52000	48000	29300	46000	48000	32000	20500	38600	46000	33600	22400	33800	32600	20000	28400	6.0	
6.5	47000	44800	28100	42600	44000	31000	19500	36500	41500	32500	21400	32400	32100	19200	27700	6.5	
7.0	43000	41500	27000	39300	40300	30000	18500	34900	38300	31500	20500	30900	31700	18500	27000	7.0	
8.0	35500	34000	24900	31600	32500	27700	17000	30200	31500	29500	18900	28200	30000	17200	25000	8.0	
9.0	28000	27500	23300	26200	27000	26000	15700	25100	26400	27800	17300	24500	27300	16000	23500	9.0	
10.0		21800	22000	21500	22200	24500	14500	21300	22600	24900	15500	20900	23600	15000	20800	10.0	
11.0		18100	20100	17900	18400	20800	13500	18000	19000	21000	14000	18100	20700	13800	18200	11.0	
12.0		15100	17200	14900	15600	17800	12700	15000	16000	18000	12800	15700	17800	12700	15800	12.0	
14.0				10700	11500	13700	11200	11100	12000	13800	10900	11600	13600	11000	12200	14.0	
16.0				7900	8700	10800	10200	8300	9000	10900	9500	8800	10800	9600	9300	16.0	
18.0							8200	6300	7000	8800	8500	6700	8800	8600	7400	18.0	
20.0								4700	5500	7200	7600	5200	7200	7700	5800	20.0	
22.0								3600	4300	5900	6400	4000	5900	6700	4500	22.0	
24.0													3000	4900	5700	3500	24.0
26.0													2300	4000	4800	2700	26.0
28.0															2200	28.0	
30.0															1600	30.0	
32.0																32.0	
34.0																34.0	
36.0																36.0	
38.0																38.0	
40.0																40.0	
42.0																42.0	
	2#	0	46	0	92	46	0	0	92	46	0	0	92	0	0	92	2#
	3#	0	0	0	0	46	0	0	46	46	0	0	46	46	0	46	3#
	4#	0	0	0	0	0	0	0	0	46	46	0	46	46	0	46	4#
	5#	0	0	0	0	0	46	0	0	0	46	46	0	46	92	46	5#
	6#	0	0	46	0	0	46	92	0	0	46	92	0	46	92	0	6#
	16	10	6	9	8	6	5	7	7	6	5	6	5	4	4		

Remark: the rating with * requires two additional sheaves.





带 * 值需安装 2 个辅助滑轮

Load Chart-Telescopic Boom

性能表 - 主臂

Unit: kg







	32.5	32.5	36.5	36.5	36.5	40.5	40.5	40.5	44.5	44.5	44.5	48.5	48.5	52.5	56.0		
2.5																2.5	
3.0																3.0	
3.5																3.5	
4.0																4.0	
4.5																4.5	
5.0																5.0	
5.5																5.5	
6.0	27000	19800														6.0	
6.5	27000	19100														6.5	
7.0	27000	18500	21700	19200	16000											7.0	
8.0	26300	17200	21700	19200	15000	18000	15000	14500								8.0	
9.0	25500	16200	21000	19200	14200	18000	15000	13800	14800	12800	12400					9.0	
10.0	22200	15100	19800	18800	13400	18000	15000	13200	14800	12800	12400	12000	10800			10.0	
11.0	19400	13800	18100	18100	12600	17000	14500	12600	14200	12200	12000	12000	10800	10000		11.0	
12.0	16700	12700	16500	17100	11900	16000	13600	12000	13600	11800	11500	12000	10800	9800	8500	12.0	
14.0	13200	11000	12800	13700	10600	12300	12500	11000	12000	10800	10700	11200	10400	9600	8500	14.0	
16.0	10300	9700	10000	10900	9500	9800	11000	9800	9700	9900	9800	9800	9500	9400	8500	16.0	
18.0	8300	8700	8000	8800	8600	7800	8900	8800	7900	8900	9000	8000	8700	8100	7900	18.0	
20.0	6700	7900	6400	7200	7800	6300	7300	7700	6400	7300	7500	6500	7100	6800	6700	20.0	
22.0	5500	6700	5200	6000	6700	5000	6100	6500	5200	6100	6100	5400	5900	5600	5500	22.0	
24.0	4500	5700	4100	4900	5700	4000	5100	5500	4200	5100	5200	4400	4900	4600	4600	24.0	
26.0	3700	4900	3300	4100	4700	3200	4300	4600	3400	4300	4400	3600	4100	3800	3800	26.0	
28.0	3000	4200	2600	3500	4100	2600	3600	4000	2700	3600	3700	2900	3400	3200	3100	28.0	
30.0	2400	3700	2100	2900	3500	2000	3000	3400	2100	3000	3100	2300	2800	2600	2600	30.0	
32.0			1600	2400	3000	1600	2500	2900	1600	2600	2600	1800	2300	2100	2100	32.0	
34.0			1100	2000	2500	1100	2100	2500	1100	2100	2200	1400	1900	1700	1700	34.0	
36.0							1700	2100		1800	1800	1200	1500	1300	1300	36.0	
38.0							1500	1800		1500	1500		1200	1000	1000	38.0	
40.0										1100	1300					40.0	
42.0											1000					42.0	
	2#	46	0	92	46	0	92	46	0	92	46	0	92	46	92	100	2#
	3#	46	0	46	46	0	92	46	46	92	46	92	92	92	92	100	3#
	4#	46	46	46	46	92	46	46	92	92	92	92	92	92	92	100	4#
	5#	46	92	46	46	92	46	92	92	46	92	92	92	92	92	100	5#
	6#	46	92	46	92	92	46	92	92	46	92	92	46	92	92	100	6#
	4	4	4	4	4	4	4	4	4	4	4	4	4	4	4		

Load Chart-Telescopic Boom

性能表 - 主臂

Unit: kg







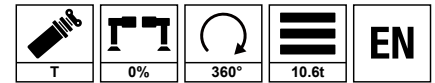

	12.5	16.5	20.5	24.5	28.5	32.5	36.5	40.5	40.5	44.5	44.5	48.5	52.5	56.0		
3.0	75000	36000	36000												3.0	
3.5	67000	36000	36000	36000											3.5	
4.0	60000	35900	36000	36000											4.0	
4.5	53000	33900	36000	36000	33000										4.5	
5.0	48000	32400	34800	36000	32900										5.0	
5.5	35000	30800	32900	34700	32800										5.5	
6.0	30300	29300	31000	33500	32000	27000									6.0	
6.5	26700	27000	29200	31000	30000	25000									6.5	
7.0	24500	24500	27400	27500	27400	23000	19000								7.0	
8.0	20100	19700	21800	21800	21500	20000	18000	17000	14300						8.0	
9.0	16200	16100	17800	17800	17700	16800	16100	17000	13700	14500	12000				9.0	
10.0		13500	15000	15000	14800	14000	13800	15100	13000	13500	12000	10500			10.0	
11.0		11400	12700	12800	12600	11900	11600	13000	12300	11500	12000	10500	10000		11.0	
12.0		9700	11000	11000	10800	10200	10000	11200	11000	9900	10600	10000	9500	8000	12.0	
14.0			8500	8400	8300	7800	7500	8400	8600	7500	8300	8000	7700	7400	14.0	
16.0			6600	6600	6600	6100	5800	6400	6800	5800	6600	6300	6100	6100	16.0	
18.0			5100	5300	5300	4900	4500	4900	5600	4600	5300	5100	4800	4900	18.0	
20.0				4300	4300	3900	3600	3800	4600	3600	4400	4100	3900	3900	20.0	
22.0				3500	3500	3100	2800	2950	3800	2800	3700	3300	3100	3000	22.0	
24.0					2800	2400	2200	2200	3200	2200	3000	2700	2500	2500	24.0	
26.0						1900	1600	1600	2600	1700	2500	2200	2000	2000	26.0	
28.0						1500	1100	1000	2200	1200	2100	1800	1500	1600	28.0	
30.0									1800		1700	1400	1100	1200	30.0	
32.0									1500		1300	1000			32.0	
34.0									1200		1000				34.0	
	2#	0	0	0	0	0	46	92	92	0	92	0	46	92	100	2#
	3#	0	0	0	0	46	46	46	92	46	92	92	92	92	100	3#
	4#	0	0	0	46	46	46	46	46	92	92	92	92	92	100	4#
	5#	0	0	46	46	46	46	46	46	92	46	92	92	92	100	5#
	6#	0	46	46	46	46	46	46	46	92	46	92	92	92	100	6#
	11	6	6	6	5	4	4	4	4	4	4	4	4	4		

Load Chart-Telescopic Boom

性能表 - 主臂

Unit: kg



	12.5	16.5	20.5	24.5	28.5	32.5	36.5	40.5	40.5	44.5	44.5	48.5	52.5	56.0		
3.5	28000														3.5	
4.0	24000	22200													4.0	
4.5	21000	20000	21600												4.5	
5.0	19500	18800	19100	18000	18300										5.0	
5.5	17200	16700	17000	16000	16500	16000									5.5	
6.0	14900	14700	15000	14200	15100	14000									6.0	
6.5	12900	13000	13500	13000	13500	12500									6.5	
7.0	11300	12000	12100	11800	12300	11100	11000								7.0	
8.0	8900	9700	10000	9600	10000	9300	9000	9000	10000						8.0	
9.0	7000	7900	8300	7900	8300	7700	7500	7400	8500	7500	8700				9.0	
10.0		6600	7000	6600	7000	6500	6200	6200	7200	6500	7400	6500			10.0	
11.0		5500	5800	5600	5900	5400	5200	5100	6200	5500	6300	5500	5600		11.0	
12.0		4600	4900	4600	5000	4500	4300	4200	5200	4600	5400	4500	4600	5000	12.0	
14.0			3500	3200	3500	3300	3000	2900	4000	3300	4000	3500	3400	3500	14.0	
16.0			2500	2100	2600	2300	1900	2000	3000	2300	3000	2500	2400	2500	16.0	
18.0				1500	1800	1300	1200	900	2300	1200	2300	1500	1700	1800	18.0	
20.0									1700		1700	1000		1300	20.0	
22.0									1300						22.0	
	2#	0	0	0	0	0	46	92	92	0	92	0	46	92	100	2#
	3#	0	0	0	0	46	46	46	92	46	92	92	92	92	100	3#
	4#	0	0	0	46	46	46	46	46	92	92	92	92	92	100	4#
	5#	0	0	46	46	46	46	46	46	92	46	92	92	92	100	5#
	6#	0	46	46	46	46	46	46	46	92	46	92	92	92	100	6#
	4	4	4	4	4	4	4	4	4	4	4	4	4	4		

Operating Range - Fixed Jib

起升高度曲线 - 副臂

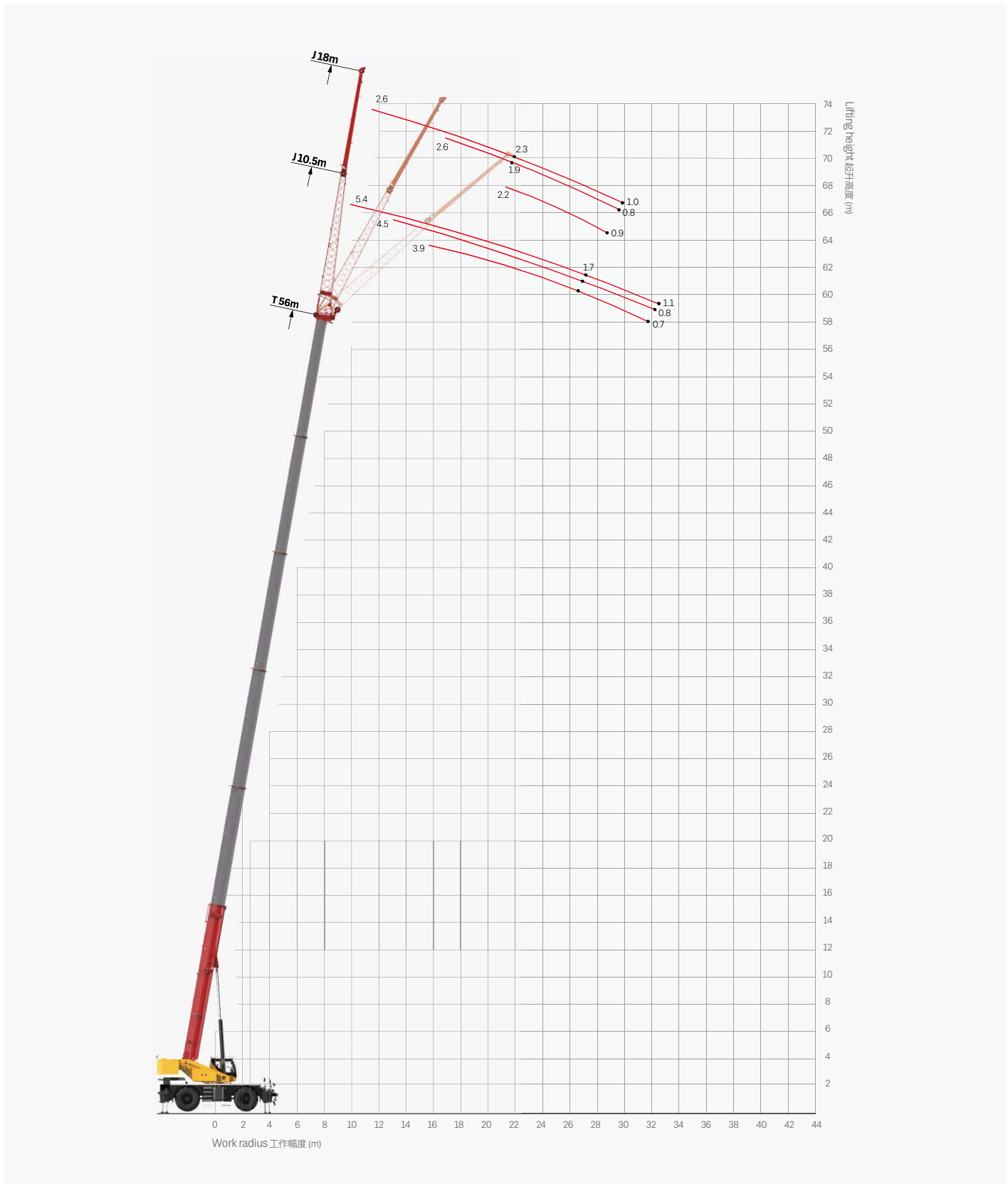



Load Chart - Fixed Jib

性能表 - 副臂

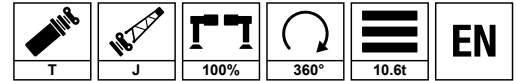
Unit: kg







	56.0m+10.5m			56.0m+18m			
	0°	20°	40°	0°	20°	40°	
80	5400	4500	3900	3000	2600	2200	80
79	5300	4500	3800	3000	2500	2200	79
78	5100	4400	3700	2900	2500	2200	78
77	4900	4300	3600	2900	2400	2100	77
76	4700	4100	3400	2900	2400	2100	76
75	4500	3900	3200	2800	2300	2100	75
73	4100	3700	2900	2700	2200	2000	73
70	3000	2700	2500	2300	1900	1800	70
68	2400	2300	2100	1900	1500	1400	68
65	2000	1900	1700	1300	1100	1100	65
63	1700	1600	1400	1000	800	900	63
60	1400	1200	1100				60
58	1100	800	700				58

Load Chart - Telescopic Boom, Pick & Carry, Load Over Front

性能表 - 主臂带载行驶 (正前方)

Unit: kg









	12.5m	16.5m	20.5m	24.5m	28.5m	
4.5	15100					4.5
5.0	13600					5.0
5.5	12300					5.5
6.0	11100	13000				6.0
6.5	10000	12000				6.5
7.0	9100	11000				7.0
8.0	7500	9000	10000			8.0
9.0	6200	8000	8500	8600	8700	9.0
10.0		6500	7100	7500	7700	10.0
11.0		5400	6000	6500	6800	11.0
12.0		4500	5100	5800	6200	12.0
14.0			3700	4500	4800	14.0
16.0			2800	3700	3800	16.0
18.0				2700	2800	18.0
20.0				1900	2100	20.0
22.0					1400	22.0
	2#	0	0	0	0	2#
	3#	0	0	0	0	3#
	4#	0	0	0	0	4#
	5#	0	0	0	46	92
	6#	0	46	92	92	92
	4	4	4	4	4	

Load Chart - Telescopic Boom, On Tires Stationary, Load Over Front

性能表 - 轮胎静止吊载 (正前方)



Unit: kg





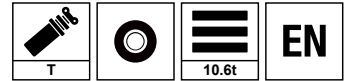

	12.5m	16.5m	20.5m	24.5m	28.5m			
4.5	19800					4.5		
5.0	17700					5.0		
5.5	16000					5.5		
6.0	14400	14100				6.0		
6.5	13100	12900				6.5		
7.0	11900	11900				7.0		
8.0	9900	9700	10600			8.0		
9.0	8300	8300	9000	9000	9100	9.0		
10.0		7000	7600	7800	8100	10.0		
11.0		5900	6500	6700	7100	11.0		
12.0		5000	5500	6000	6500	12.0		
14.0			4000	4700	5000	14.0		
16.0			3000	3800	4000	16.0		
18.0				2800	3000	18.0		
20.0				2000	2300	20.0		
22.0				1300	1600	22.0		
24.0					1100	24.0		
	2#	0	0	0	0	2#		
	3#	0	0	0	0	3#		
	4#	0	0	0	0	4#		
	5#	0	0	0	46	92		5#
	6#	0	46	92	92	92		6#
	4	4	4	4	4			

Load Chart - Telescopic Boom, On Tires Stationary, 360° Slewing

性能表 - 轮胎静止吊载 (360°)

Unit: kg



 m	12.5m	16.5m	20.5m	24.5m	28.5m	 m		
4.5	12000					4.5		
5.0	9800					5.0		
5.5	8300					5.5		
6.0	7000	7900				6.0		
6.5	5700	6900				6.5		
7.0	4900	6000				7.0		
8.0	3500	4600	4900			8.0		
9.0	2400	3600	3900	4100	4200	9.0		
10.0		2800	3100	3300	3400	10.0		
11.0		2100	2400	2600	2700	11.0		
12.0		1300	1800	2000	2100	12.0		
14.0			1000	1200	1300	14.0		
	2#	0	0	0	0	0	2#	
	3#	0	0	0	0	0	3#	
	4#	0	0	0	0	0	4#	
	5#	0	0	0	46	92	5#	
	6#	0	46	92	92	92	6#	
	4	4	4	4	4	4		

Remark

- Capacities are applicable at 525kPa cold tire inflation pressure.
- Capacities are applicable only with machine on firm level surface.
- On tire lifting with the jib mounted is not permitted.
- Axle lockouts must be applied when lifting on tires.
- Parking brake must be applied when lifting on tires stationary.
- Driving speed shall be ~4km/h at pick & carry mode.

- 冷态轮胎气压需保持 525kPa。
- 起重机需在平整坚固的地面上作业。
- 轮胎吊载工况不允许使用副臂吊载。
- 轮胎吊载工况中，车桥悬挂需锁定。
- 轮胎静止吊载工况中，需使用驻车制动。
- 带载行驶工况中，直线行驶速度需小于等于 4km/h。



SANY GROUP CRANE BU

SANY Mobile Crane Industrial Park, No.168 Jinzhou Avenue, Jinzhou Development Zone, Changsha City,
Hunan Province, P.R. China Zip 410600
Consulting sanycrane@sanygroup.com (Crane BU) / crd@sany.com.cn (IHQ)
After-sales Service 0086-400 6098 318

Reminder:

Any change in the technical parameters and configuration due to product modification or upgrade may occur without prior notice.
The machine in the picture may include additional equipment. This brochure is for reference only, and goods in kind shall prevail.
Copyright at SANY. No part of this brochure may be copied or used for any purpose without written approval from SANY.

© Edited in July 2023

三一集团起重事业部

中国湖南长沙金洲开发区金洲大道 168 号 三一汽车起重机产业园 邮编: 410600
咨询: sanycrane@sanygroup.com (起重事业部) / crd@sany.com.cn (国际总部)
海外售后服务: 0086-400 6098 318

温馨提示:

由于技术不断更新, 技术参数及配置如有更改, 恕不另行通知。图中机器可能包括附加设备, 本画册仅供参考, 以实物为准。
版权为三一所有, 未经三一书面许可, 本画册任何内容不得被复制用于任何目的。

© 2023 年 7 月版

