

SANY[®]

SPECIFICATION



 **350t**

 **81m**

 **81m+36m**

SAC3500T7

SANY ALL TERRAIN CRANE

QUALITY CHANGES THE WORLD

www.sanyglobal.com

V1.6

It is one of the core business units in SANY Group, specializing in the development and manufacturing of high-end wheel cranes, crawler cranes and tower cranes, including the complete range of wheel cranes from 8 to 2400t, crawler cranes from 25 to 4500t and tower cranes from 6 to 185t.

三一集团旗下核心事业部，从事高端轮式起重机、履带起重机、塔式起重机系列产品的研发制造。覆盖8-2400吨全吨位轮式起重机，25-4500吨全吨位履带起重机，6-185吨塔式起重机。



SANY CRANE



Strong lifting capacity

Telescopic boom: strong lifting capacity, max. lifting moment 990t-m. The max. capacity at 81m full-extension boom reaches 22t.

Fixed jib: variable combinations up to 36m, mechanical adjustment at 0°/20°/40°, max. lifting height 117m, easily coping with lifting tasks at different height.

Equipped with superlift device, the lifting capacity of long boom is significantly increased. Self dis/assembly of superlift device is realized without any auxiliary crane.

Wind power configuration: 37t capacity at 80m height, covering < 1.5MW wind turbine overhauling needs.

Excellent driving performance

Innovative six-axle chassis, all-wheel steering and four-axle drive, and a variety of steering and drive modes deliver strong driving flexibility.

The new intelligent multi-mode hydro-pneumatic suspension functions real-time vehicle attitude monitoring, active lifting and variable damping adaptation, etc., making driving more comfortable and stable.

With a strong power and transmission system equipped with hydraulic converter and retarder brake, the driving safety and smoothness are greatly improved. Max. traveling speed reaches 80km/h and max. gradeability is up to 50%.

High efficiency and reliability

Multi-pump and multi-circuit hydraulic system, electro proportional and multi-level pressure control to realize speed grading and inching mobility, achieving better performance.

The new superlift stable tensioning control technology, one-key auto tensioning and swing away/back, improves the operation efficiency by 20% and the lifting performance of medium and long boom is increased significantly.

High level safety

The multifunctional wireless remote control system facilitates operation convenience and safety.

The anti-tipping early-warning system, safety protection program and fault diagnosis system make the operation safe and reliable.

The LMI system is designed with high precision, high stability and high intelligence is adopted to protect the lifting operation in an all-round way.

Equipped with adequate sensors for timely data feedback, real-time monitoring, and mastering the working state of the vehicle at any time.



起重性能强

主臂：起重能力强，基本臂最大起重力矩990t·m；全伸臂长81m，最大吊重22t。
副臂：副臂36m，多种臂长组合、角度0°/20°/40°可调，最大起升高度117m，吊高吊远吊重全能兼备。
超起装置：不用辅助吊车可实现自拆装，可大幅提高长臂段起重性能。
风电专用工况：80m高吊重37t，满足1.5MW以下风电检修需求。

行驶性能卓越

创新六桥底盘，全轮转向、四桥驱动，多种转向及驱动模式，行驶适应能力超强。
全新智能多模式油气悬挂系统，车体姿态实时监控、主动提升和变阻尼自适应等功能，驾乘更舒适，行驶更稳定。
强劲动力及传动系统，最高行驶速度80km/h、最大爬坡度50%，配备液力变矩、缓速制动，极大提高行驶安全性和平顺性。

高效可靠

多泵、多回路液压系统，电比例及多级压力控制，实现速度分档和微动性优化，性能更卓越。
全新定长张紧控制技术，智能一键张紧及收/展超起，作业效率提升20%，中长臂段起重性能大幅度提升。

安全可靠

多功能无线遥控系统，起重机作业更加方便，操作更加安全。
配备防倾翻预警系统，操作安全保护程序及故障诊断系统，保证车辆的作业安全。
采用高精度、高稳定性、高智能化的力矩限制器系统，全方位保护吊载作业。
配置丰富的传感器件，及时反馈数据信息，实时监控，随时掌握整车工作状态。

SAC3500T7

SANY ALL TERRAIN CRANE
350T LIFTING CAPACITY





i-Cab -Driver's cab

新两室 - 驾驶室

Multi-function seat with air suspension, making driving more comfortable.

Double seats and foldable berth for the co-driver.

12.1-inch automotive grade dash screen integrated with back-up image and multi-media.

Electric rearview mirror with electric heating, ensuring good field of view in foul weather.

Adjustable high-brightness LED headlamps/fog lamps, providing clear vision at night.

Full-automatic HVAC, able to automatically adjust indoor temperature as demanded.

驾驶位配备气浮多功能座椅, 驾驶更舒适。

副驾驶位设置双座椅可折叠式卧铺。

12.1英寸车规级中控屏, 集成倒车影像、影音娱乐功能。

电动、电加热后视镜, 不惧怕恶劣冰雪天气。

高亮度可调节 LED 大灯 / 雾灯, 夜间视野清晰。

全自动冷暖空调, 自动根据需求调整室内温度。

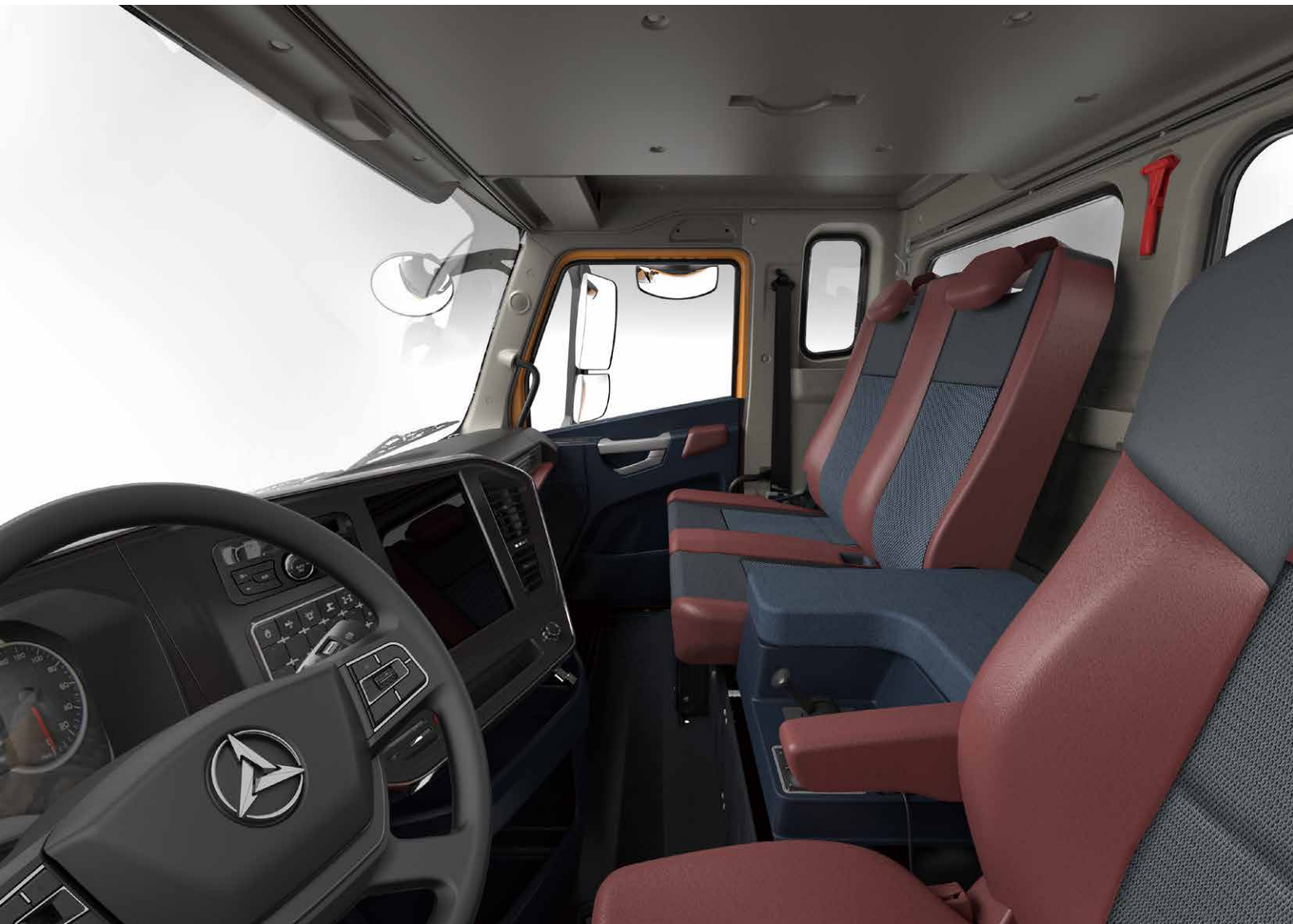



i-Cab - Operator's cab

新两室 - 操纵室

Seat widened by 480mm, and leg room increased by 30%.

Cab tiltable by 0-20°, relieving cervical fatigue during large-angle and long-boom operations.

Adjustable seat with maximum inclination of 140°, allowing the operator to lie flat and rest after work.

Electric seat linked with armrest, enabling multi-dimensional adjustment for enhanced comfort.

Electronic control joysticks, making operation easier.

Ergonomically positioned control panels, easy to reach and operate.

70° openable front window convenient for ventilation and escape, in compliance with CE standards.

Curved-track sliding door, more convenient for getting on/off the cab and opening/closing the door.

Full-automatic HVAC, automatically adjusting indoor temperature as demanded.

Double 10.1-inch display screens.

座椅加宽至 480mm，腿部活动空间较上一代增加 30%。

操纵室可实现 0-20° 上仰变位，大角度、长臂段作业时减缓颈椎疲劳。

可调式座椅，最大后仰 140°，操作手可平躺休息。

电动座椅 + 扶手箱联动，多维度调节，更加舒适。

电控操纵手柄，操作毫不费力。

配备功能面板及左右扶手箱动作按键面板，触手可及，方便操控。

70° 可开启式前窗，方便通风及逃生，操作室满足 CE 要求。

变轨滑移门，上下车、开关门更方便。

全自动冷暖空调，自动根据需求调整室内温度。

10.1 寸双屏显示。



Overall Dimensions

整机尺寸

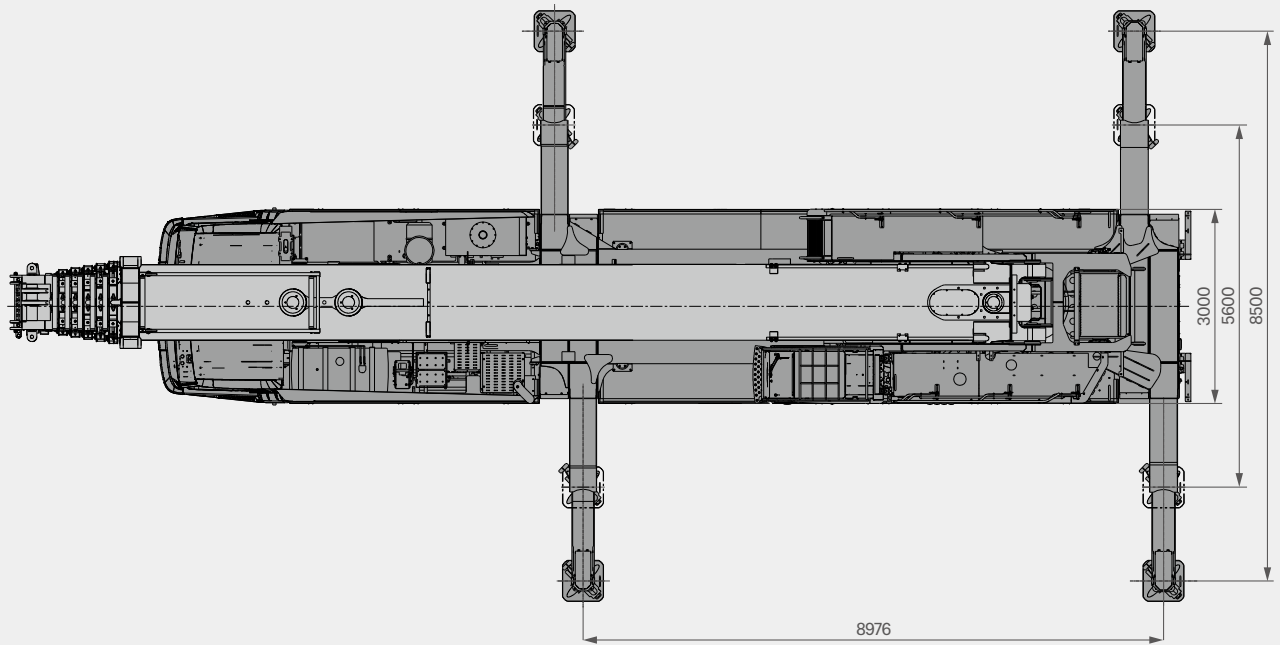
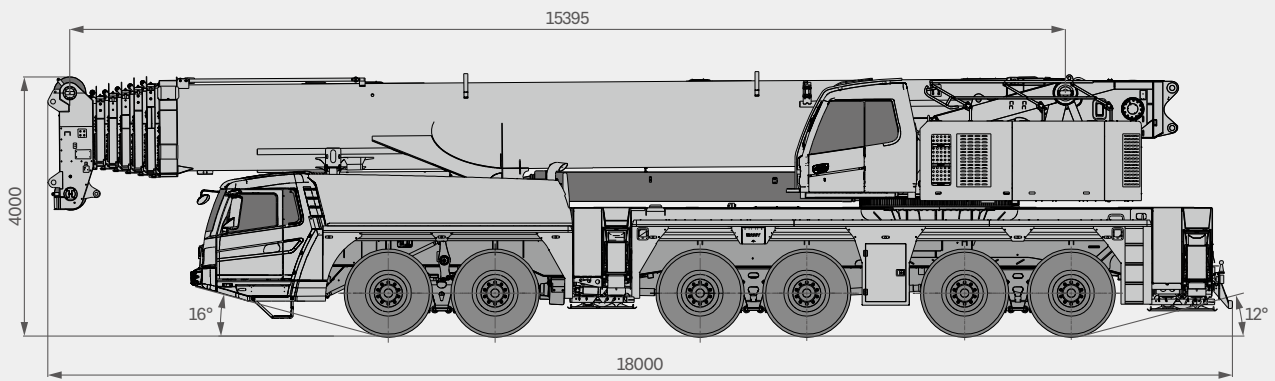

Technical Specification

整机参数

CATEGORY 类型	ITEM 项目	UNIT 单位	VALUE 参数	
CAPACITY 额定起重量	Max. lifting capacity 最大起重量	t	350	
WEIGHT 重量	Gross weight 整机总质量	kg	72000 (excl. outriggers, spare tire and its bracket 不带活动支腿、备胎及备胎支架)	
POWER (CHASSIS) 发动机参数 (下车)	Engine model 发动机型号 (排放标准)	-	Benz OM471LA.E3A-7 (EU Stage IIIA)	
	Max. engine power 发动机最大功率	kW/rpm	390/1600	
	Max. engine torque 发动机最大输出扭矩	N·m/rpm	2600/1300	
POWER (SUPERSTRUCTURE) 发动机参数 (上车)	Engine model 发动机型号 (排放标准)	-	Benz OM906LA.E3A/1 (EU Stage IIIA)	
	Max. engine power 发动机最大功率	kW/rpm	205/2200	
	Max. engine torque 发动机最大输出扭矩	N·m/rpm	1100/1200-1600	
DIMENSIONS 尺寸参数	Overall length 整机全长	mm	18000	
	Overall width 整机全宽	mm	3000	
	Overall height 整机全高	mm	4000	
TRAVEL 行驶参数	Max. travel speed 最高行驶速度	km/h	80	
	Steering radius 转弯半径	Min. steering radius 最小转弯半径	m	11.68
		Min. steering radius of boom tip 臂头最小转弯半径	m	14.4
	Wheel formula 车轮模式	-	12 × 8 × 12	
	Min. ground clearance 最小离地间隙	mm	360	
	Approach angle 接近角	°	16	
	Departure angle 离去角	°	12	
	Max. gradeability 最大爬坡度	-	49%	
	Fuel consumption per 100km 每 100 公里油耗	L	≤100	
MAIN PERFORMANCE 主要性能参数	Working temperature range 使用温度区间	℃	-20~+40	
	Min. rated lifting radius 最小额定幅度	m	3	
	Tail slewing radius 转台尾部回转半径	m	6.32	
	Boom sections (Qty.) 臂节数	-	7	
	Boom shape 臂形状	-	U shape U型	
	Max. lifting moment 最大起重力矩	Basic boom 基本臂	kN·m	9900
		Full-extension boom 全伸主臂	kN·m	5400
		Full-extension boom + fixed jib 全伸主臂 + 固定副臂	m	1340
	Boom length 臂长	Basic boom 基本臂	m	15.4
		Full-extension boom 全伸主臂	m	81
		Full-extension boom + fixed jib 全伸主臂 + 固定副臂	m	74.8+36
	Outrigger span (Longitudinal × Transverse) 支腿跨距 (纵 × 横)	m	8.95 × 8.5	
	Jib offset 副臂安装角度	°	0, 20, 40	
AIRCONDITIONER 空调	In operator's cab 上车空调	-	Heating & Cooling 制冷、制热	
	In driver's cab 下车空调	-	Heating & Cooling 制冷、制热	

Technical Specification

整机参数



Axle Load 轴荷

Axle 轴	1	2	3	4	5	6	Gross weight 总重量
Axle load 轴荷 /t	12	12	12	12	12	12	72

Remark 备注:

72t weight requires removing outriggers, hook blocks, counterweight frame, and superlift device.
不含活动支腿、吊钩、配重架及超起用相关附件。



Hook 吊钩

Load 起重量 /t	Number of sheaves 滑轮数量	Rope rate 倍率	Hook weight/kg 吊钩重量
160 ○	7	14	1627
80 ●	3	7	723
32 ●	1	3	521
12.5 ball hook ○	0	1	526

● Standard 标配 ○ Optional 选配



Operations 主要动作参数

Item 项目	Max. single rope lifting speed (empty load) 单绳速度 (空载)	Rope diameter/length 钢丝绳直径 / 长度	Max. single line pull 最大单绳拉力
Main winch 主卷扬	130m/min	24mm/400m	13.5t
Slewing speed 回转速度	1.2r/min		
Full luffing up/down time of boom 主臂起落幅时间	75s/110s		
Full extension/retraction time of boom 主臂伸缩时间	780s		
Outrigger jack 垂直支腿	Extension 伸	50s	
	Retraction 缩	55s	
Outrigger beam 水平支腿	Extension 伸	30s	
	Retraction 缩	30s	

Counterweight Combinations

配重组合



Total weight (t) 总重量	Counterweight Combinations 配重组合
0	/
20	①
30	① + ③ * 2
40	① + ② * 2
50	① + ② * 2 + ③ * 2
60	① + ② * 4
70	① + ② * 4 + ③ * 2
80	① + ② * 6
90	① + ② * 6 + ③ * 2
100	① + ② * 8
110	① + ② * 8 + ③ * 2
120	① + ② * 9 + ③ * 2

- ① CW frame & base plate 配重架及托盘 20t
- ② CW block 配重块 10t*9
- ③ CW block 配重块 5t*2

Fixed Jib Combinations

副臂组合

Without superlift device 不带超起

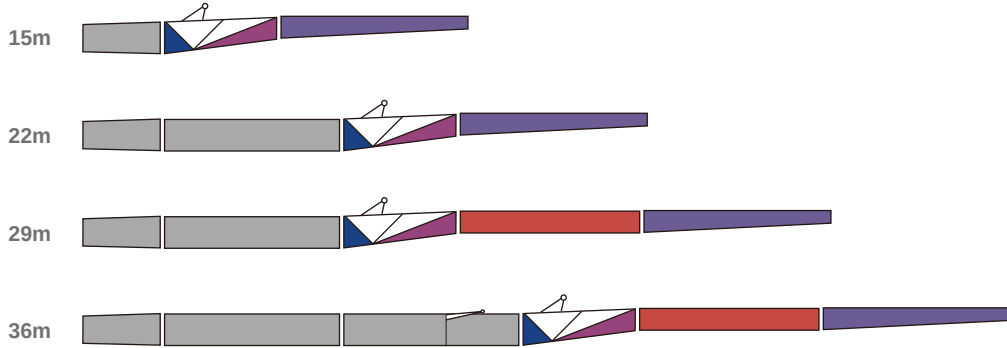

With superlift device 带超起

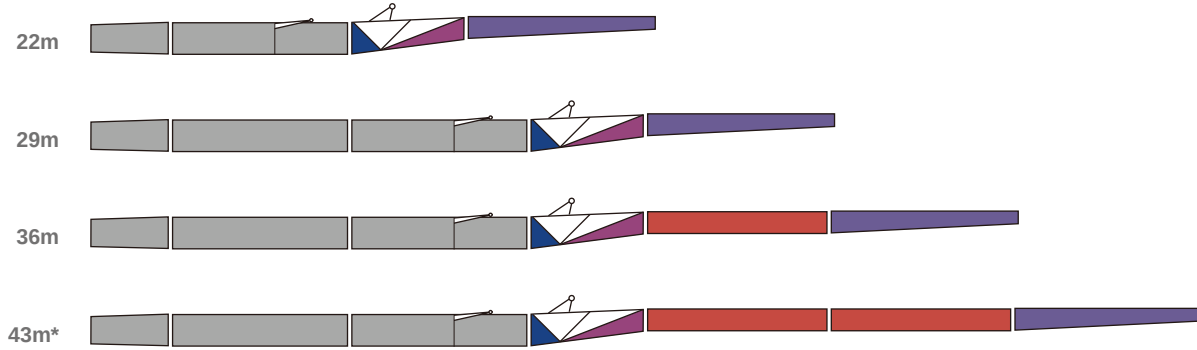

* Optional 选配

Crane Introduction

整机介绍

Carrier 下车

Driver's cab 驾驶室

- Three seats with a folding berth. It's soundproofing performance meets the standard of heavy duty trucks. Air suspension seat features shock absorption, back adjustment, lumbar support and other ergonomic designs. Virtual LCD instrument and 12.1" console screen integrate auto control of air conditioning. Indoor temperature can be adjusted precisely and smoothly. LED headlights, electrically heated rear-view mirrors, multifunction steering wheel. The multi-media equipment can be controlled by the buttons integrated in the steering wheel.
- 三座椅，二合一卧铺。车门关闭后，隔音性达到国际重卡水平。空气悬浮减震座椅，集成背部调节、气囊腰托、人体工程学配置。液晶、虚拟仪表盘。12.1寸中控大屏；集成自动空调控制界面，精准控温，出风柔顺。LED前大灯，电动电热后视镜；多功能方向盘，可控制车内多媒体设备。

Carrier frame 车架

- Developed and manufactured by Sany, the frame is optimized to anti-torsion box structure welded by fine grain high-tensile steels. The outriggers are retracted in fixed boxes placed between axle 2 and 3 and frame tail. Front and rear towing devices available.
- 三一自主研发并专业化制造，结构优化，防扭转箱型结构，细晶粒高强度钢板焊接制作；支腿收缩在特制固定箱中，支腿箱位于2桥和3桥之间以及车架尾部；并且配备前后牵引挂钩。

Chassis engine 底盘发动机

- Model: Electronically controlled, in-line six cylinder, water-cooled, supercharged intercooled diesel engine.
- Power: 390kW/1600rpm.
- Torque: 2600N·m/1300rpm.
- Emission standard: complying with EU Stage IIIA.
- Fuel reservoir capacity: approx. 550L.
- 型式：电控、直列六缸、水冷却、增压中冷、电喷、柴油发动机。
- 额定功率：390kW/1600rpm。
- 最大扭矩：2600N·m/1300rpm。
- 环保性：排放符合欧III标准。
- 燃料箱容量：约550L。

Transmission 变速箱

- ZF auto transmission, with integral hydraulic retarder for wear-free brake, features a wide range of speed ratio with 12 forward speeds and 2 reversing speeds and self-adaptive gearshift program, which is adaptable to slope climbing and high-speed traveling on public roads.
- 德国ZF原装进口变速箱，速比范围大（12个进档、2个倒挡），智能自适应换挡程序，一体式液力缓速器无磨损制动，极致爬坡脱困能力，既可满足低速场地爬坡又可满足公路高速行驶。

Axle 车桥

- Heavy-duty axles with disc brake, all wheel steering. Axle 1, 3, 5, and 6 are drive axles. Axle 6 is fitted with disengagement device. Three axle drive on public roads, four axle drive on tough terrains. Axle 1 and 2 are steered mechanically with hydraulic booster; axle 3 to 6 are steered by electro hydraulic power, which helps control travel speed and provides special steering mode, featuring easy steering and flexible maneuverability.
- 重载车桥，盘式制动，全桥转向，一、三、五、六桥为驱动桥，其中六桥带脱开装置，正常公路行驶三桥驱动，复杂路面四桥驱动。一、二桥采用杆系反馈的液压助力转向系统，三至六桥采用电液控制转向，可进行速度控制的辅助及可选择的特殊转向模式，转向轻便，操控灵活。

Suspension system 悬挂系统

- Multi-mode height adjustable (+160mm/-130mm) hydro-pneumatic suspension devices with hydraulic lockout, which can realize five modes incl. suspension, rigid locking, auto leveling, whole vehicle rising and single point rising & lowering. It can conduct real-time monitoring of vehicle attitude, smart identifying of axle load, active rising and self-adaptability to tough terrains, ensuring smoothness and lateral stability during driving.
- 智能多模式油气悬挂系统，悬架高度可调（+160mm/-130mm），带液压闭锁装置，能实现悬挂、刚性锁定、自动调平、整车升降、单点升降五种模式。具备车体姿态实时监控、轴荷智能识别、主动提升和复杂路面自适应等功能，驾乘更舒适，行驶更稳定。

Steering 转向系统

- All new constant pressure and constant flow steering system featuring linear following without lag and precise steering angle. Three steering emergency systems available. The steering mode is adjusted according to the speed. Starting from 30km/h, axle 3 and 4 stop steering, and by 60km/h, axle 5 and 6 stop steering.
- Six steering modes: 1) on-road driving (default); 2) all wheel steering; 3) crab steering; 4) reduced swing out steering; 5) independent rear axle steering; 6) independent front axle steering.
- 全新的恒压恒流量智能转向系统，线性跟随无滞后，转角精准零偏差；三重转向应急系统，行驶更加安全可靠；转向策略根据速度调节，从30km/h开始3、4桥不转向，从60km/h开始5、6桥不转向。
- 可分为六种转向模式：1) 公路行驶模式（默认模式）；2) 全转向模式；3) 蟹形模式；4) 无偏摆转向模式；5) 独立后桥转向模式；6) 后桥锁定转向模式。

Tires 轮胎

- 12 radial tires - 16.00R25 (445/95 R25).
- 12个轮胎—16.00R25 (445/95 R25)。

Wheel formula 车轮模式

- 12 × 8 × 12.

Crane Introduction

整机介绍

Carrier 下车

Outrigger 支腿

- H-type two-stage telescopic outriggers. The hydraulic system of outrigger telescoping adopts electro proportional control with wireless remote controller. The control panel can display load on outriggers, and has the function of auto leveling, featuring high precision and easy operation. Outrigger pad (2.8m × 1.9m × 0.18m) available.
- 活动支腿采用双 H 型两级伸缩支腿，支腿伸缩液压系统采用电比例控制技术，并配置有无线遥控，支腿控制面板可显示所承受的载荷，并具有自动调平等功能，控制精度高，操作简便。标配支腿垫板（2.8m × 1.9m × 0.18m）。

Brake 制动系统

- Dual circuits, air brake, disc brakes available.
- Service brake: air servo brakes on all wheels, dual circuits, all wheels equipped with disc brakes.
- Parking brake: actuated by pressure accumulators on axles 2 to 6.
- Assist brake: engine brake and exhaust brake, transmission hydraulic retarder brake.
- 双回路、气制动、配备盘式制动器。
- 行车制动器：所有车轮均采用空气伺服制动器，双回路制动系统，新型盘式制动器。
- 驻车制动器：由蓄压器驱动作用在第二至第六桥上。
- 辅助制动器：发动机上带有发动机制动及排气制动器、变速箱配备液力缓速制动。

Electrical system 电气系统

- 24V DC power supply with lighting system, chassis power cut-off available. The throttle and outrigger are controlled by electrical system, which makes the movements easy and fast. The electrical system has strong detection, logic and calculation capabilities, with fault self-diagnosis, centralized display and self-protection functions.
- The chassis adopts CAN-Bus system, which is fast, stable and accurate. the centralized display system is multi-functional; the protection level is as high as IP65; the power consumption is small, which is only 5W at most; four function keys are provided in the user interface; LCD screen is with adjustable contrast.
- 采用 24V 直流电源，可实现下车电源切断；配备汽车照明系统；车辆的动作，如油门、支腿操纵等都经电气控制实现，使动作轻便、快捷；电气系统有很强的检测、逻辑、运算等能力，具故障自诊断、集中显示及自我保护功能；
- 底盘采用 CAN 总线系统，具有数据快速、稳定、准确等优点；多功能的集中显示系统；防护等级高，IP65；功率消耗小，最大仅有 5w；在用户界面提供四个功能键；显示采用 LCD 液晶，对比度可调整。

Crane Introduction

整机介绍

superstructure 上车

Operator's cab 操纵室

- Curved track sliding door, foldable front step and electric side step. The seat and armrest can be adjusted steplessly in multi ways electrically. Auto air conditioning system gives out airflow from various vents once pressing the virtual key. Windshield wiper covers large area, ensuing clear vision in heavy rains. Double 10.1" frameless displays of all new UI is equipped. Operation is realized via touchscreen and buttons.
- 变轨滑梯门, 电动滑梯踏板, 折叠式前踏板; 座椅、扶手箱多维度电动无极调节; 汽车级集成式硬质按键, 配置全自动空调, 多通道立体送风系统, 虚拟空调按键, 前窗分体式大面积雨刮; 双 10.1 寸无框大屏, 全新 UI 界面, 触摸、按键多模式操作。

Superstructure engine 上车发动机

- Model: Mercedes-Benz OM906LA.E3A, electronically controlled, inline six-cylinder, water-cooled, supercharged intercooled, diesel engine.
- Power: 205kW/2200rpm.
- Torque: 1100N·m/1200~1600rpm.
- Emission standard: complying with EU Stage IIIA.
- Fuel reservoir capacity: 300L.
- 型式: 型号奔驰 OM906LA.E3A, 电控、直列六缸、水冷却、增压中冷、柴油发动机;
- 功率: 205kW/2200rpm;
- 最大扭矩: 1100N·m/1200~1600rpm;
- 环保性: 排放符合国 III 标准;
- 燃料箱有效容积: 300L。

Boom & telescoping system 臂架系统

- Telescopic boom: one base section plus six telescoping sections. Bended and welded using fine grain high tensile steel. Oval profile of torsion resistance. Single cylinder auto pinning telescoping mechanism. One double acting cylinder controls all sections for variable length combinations. Basic boom 15.4m, full extension 81m.
- Jib: fixed jib features variable combinations from 15m to 36m (incl. adapter). Jib offsettable at 0°/20°/40° depending on real needs.
- Superlift device: independently arranged at left and right sides of the base boom head, self assembled and disassembled requiring no helper crane. The superlift device makes the force state of boom greatly improved, avoiding side bending and reducing deflection of long boom by 20%-30%, and the lifting capacity is more than doubled.
- 主臂: 由 1 节基本臂和 6 节伸缩臂组成, 采用细晶粒高强度钢板折弯、焊接制成, 采用椭圆形截面, 抗屈曲性能好; 采用单缸自动插销式系统, 一个双作用油缸可以控制所有吊臂的伸缩, 达到多种臂长组合; 基本臂长 15.4m, 全伸臂长 81m。
- 副臂: 副臂全长 36m, 可实现 15m~36m (含转接头) 4 种臂长组合, 副臂角度 0°/20°/40° 可调, 可以根据工况的实际需要而变化角度。
- 超起装置: 布置于基本臂头部左右两侧, 左右独立, 无需辅助吊装可实现自拆装; 超起装置使得起重臂的受力状态得到很大改善, 避免旁弯, 减小起重臂的下挠变形, 起重臂在长臂状态下挠度可减小 20%-30%, 起重性能提升 200% 以上。

Hoist 起升系统

- Hydraulic motor driven planetary reducer and specialized groove drum, fitted with brake.
- Rigging: high quality wire rope lock is applied. Rope end cast and installed in lock sleeve, increasing reeving speed.
- Spec. ϕ 24-2160, anti-rotation wire rope.
- Rope length: approx. 400m.
- Max. single rope speed (the 4th layer): approx. 130m/min.
- 主起升机构: 液压马达驱动的行星齿轮减速机和专用绳槽卷扬鼓, 内置制动器。
- 钢丝绳锁具: 采用高品质钢丝绳锁, 钢丝绳端浇铸, 直接安装于锁套内, 提高了起重倍率的更换速度, 方便快捷。
- 钢丝绳规格: ϕ 24-2160, 抗旋转钢丝绳。
- 钢丝绳长度: 约 400m。
- 最大单绳速 (第四层): 约 130m/min。

Luffing system 变幅系统

- Single cylinder. Luffing angle: -0.4° ~82°.
- Double-pump flow confluence open type hydraulic circuit is adopted, and combination of active and passive luffing mechanism controlled electro proportionally, can realize fast speed at large angle and stable process at smaller angle.
- 单油缸前顶式变幅, 变幅角度 -0.4°~82°, 液压系统采用双泵合流开式液压回路, 采用电比例控制、动力落幅和自重落幅相结合, 可实现大角度快速落幅, 小角度稳定慢速落幅。

Slewing platform 转台结构

- Independently designed by Sany. Made of fine grain high-strength steel plate, the structure is optimized.
- 三一自主设计, 结构更优化。由细晶粒高强度钢制成。

Hydraulics 液压系统

- The superstructure hydraulics adopts open and closed type combined system, featuring load sensing, heavy load in low speed and smaller load in high speed, ensuring high efficiency. Luffing and telescoping systems are of open type formed by electro proportional pump and self-made main valve, functioning one-key pressure calibration and smart modification. Staged pressure and electro proportional pump displacement realized energy efficiency and operation safety. Hoist adopts close type to ensure responsive hook movement and wide speed range. Slewing closed system ensures non-time-delay start and stop. Counterweight lifting and lowering, operator's cab tilting and slewing platform lockout available.
- The pump, piston motor and balance valve come from international well-known brands of high quality and reliability. Open and closed type electro proportional pump can adjust displacement for maximized energy usage rate. Double pump confluence and shunt mode realizes pressure and flow stepless adjustment and non-interfering dual circuit control. Single motion by confluent flow and combined motions by divided flow.
- Hydraulic tank capacity: 1290L.
- 开闭式相结合的上车液压系统, 具有负载感知特性、重载低速、轻载高速、动作效率高的特点。其中变幅伸缩系统采用电控比例泵与自制主阀组成的开式系统, 具有压力一键标定以及智能修正功能, 不同动作采用不同的压力等级, 配合电比例泵排量, 从而实现节能、安全的变幅和伸缩动作; 起升卷扬系统采用闭式系统, 不仅起落钩动作响应敏捷, 还作业效率高, 调速范围宽; 回转采用闭式系统, 系统启停平稳无延时, 动作柔顺且微控性好; 除可实现上车回转、吊臂变幅、伸缩、主卷扬起落功能外, 还可实现平衡重升降、操纵室旋转、转台锁止等的功能。
- 液压泵、柱塞马达及平衡阀等关键元件均采用国际一线品牌, 品质好, 可靠性高; 开、闭式电比例泵, 实时调节排量, 实现高精度流量控制, 最大化减少能量浪费; 自主研发的双泵合流/分流主阀, 实现系统压力与流量无极调节以及互不干扰的双回路控制, 单动作双泵合流效率高, 组合动作双泵分流操控及平顺性好。
- 液压油箱容量: 1290L。

Crane Introduction

整机介绍

Control system 控制系统

- Powered by 24V DC and using IFM controller and harness wiring, the control network of CAN-BUS combined with conventional electrical system functions logic control and electro proportional control.
- System real-time monitoring and automatic fault diagnosis available.
- Hoisting, slewing and luffing are controlled by two electro proportional joysticks which can be automatically reset in multiple directions; telescoping is operated by floor-mount pedal; counterweight lifting, operator's cab tilting, slewing platform locking are all controlled by the control panel.
- The display is connected to the controller by CAN Bus, and it functions digital adjustment and display of electro proportional control parameters, display of electro proportional system fault codes, and display of real-time data of hydraulic system.
- 由24V直流电源供电，采用德国进口IFM控制器、电缆布线，CAN-BUS总线控制网络，与常规电气相结合，完成系统的逻辑控制与电比例控制功能。
- 具有系统实时监测和故障自动诊断功能。
- 起升、回转、变幅由两个可自动复位多方向电比例手柄控制；伸缩由脚踏式伸缩踏板操纵；平衡重升降、操纵室变位、转台锁止均在操控面板按键控制。
- 显示器由CAN总线与控制器联接，主要功能：电比例控制参数的数字化调整和显示，电比例系统的故障代码显示，液压系统实时检测数据的显示。

Slewing 回转系统

- Fixed displacement motor and reducer are adopted and mesh externally with the bearing. 360° slewing. Stepless speed regulation possible. Slewing speed 0-1.2rpm. The closed type slewing system reduces energy loss as well as increases efficiency. Electro-proportional brake pedal and emergency brake available.
- 由技术成熟、并在汽车起重机上广泛使用的定量马达和回转减速机组成，同时与回转支承采用外啮合形式，以实现 360° 全回转，回转速度可从 0-1.2rpm，无级调速；回转液压系统采用闭式系统，即能够避免开式系统的节流损失，又使系统具有较高的效率；电比例制动踏板，可实现紧急制动。

Safety equipment 安全装置

- The LMI calculation system ensures load accuracy ranging $\pm 3\%$ through online empty-load calibration.
- Hydraulic system is configured with hydraulic balance valve, relief valve, two-way holding valve to achieve stability and reliability.
- The main winch is equipped with third wrap indicator to prevent wire rope from over-hoist-down.
- The A2B limit switch at boom and jib heads prevents wire rope from over-hoist-up.
- Anemometer at boom head detects wind speed for operation safety.
- Superlift rope tensioning protection program, jib erection protection and load protection program available.
- 采用分析力学方法，建立了基于吊重力学模型的力矩限制器计算系统，通过在线空载标定，吊重精度达到 $\pm 3\%$ 。
- 液压系统配置液压平衡阀、溢流阀、双向液压锁等元件，实现液压系统稳定可靠。
- 卷扬配置三圈保护器，防止钢丝绳过放。
- 臂端配置高度限位器，防止钢丝绳过卷。
- 臂端装有风速仪，检测高空风速是否超过可作业允许范围。
- 超起收放绳拉力保护程序，副臂安装、吊载保护程序等。

Counterweight 配重

- Combined counterweight features 12 combinations: 0t, 20t, 30t, 40t, 50t, 60t, 70t, 80t, 90t, 100t, 110t and 120t, which can meet the needs of different working conditions and maximize the performance. Counterweight can be mounted and dismounted by remote control.
- 组合式可变平衡重。0t、20t、30t、40t、50t、60t、70t、80t、90t、100t、110t、120t 共 12 种组合方式，可满足不同工况的需求，最大限度发挥结构件性能，可遥控自行拆卸及安装，微动性好。

Optional equipment at extra fees 选配

- 7m jib insert (jib length 43m)
- 10t*2 counterweight blocks (total weight 120t)
- 12.5t hook
- 160t hook
- Wind power package
- Bridgestone tires 445/95R25
- Spare tire bracket
- Customized painting
- 7m 副臂延伸节（副臂总长 43m）
- 2 块 10t 配重（总配重 120t）
- 12.5t 吊钩
- 160t 吊钩
- 风电选配包
- 普利司通轮胎 445/95R25
- 备胎支架
- 特殊涂装

Working Conditions & Code Description

工况组合及工况代码说明

- T - Telescopic Boom 主臂
- J - Fixed Jib 固定副臂
- S - Superlift Device 超起



Operating Range - T

起升高度曲线 - 主臂

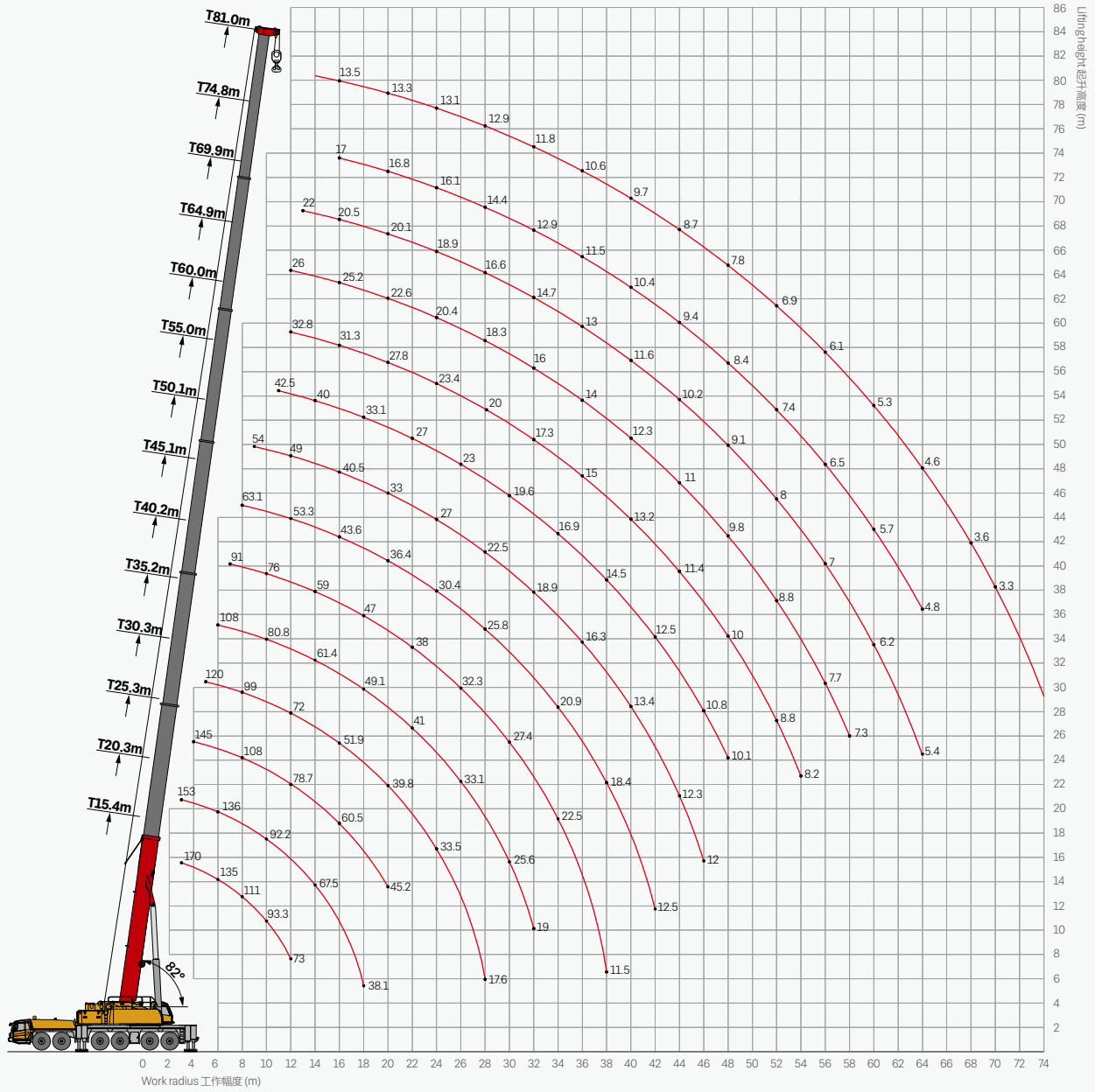







Load Chart-T

性能表 - 主臂

Unit: t



 m	15.4	20.3	25.3	30.2	35.2	40.2	45.1	50.1	55.0	60.0	64.9	69.9	74.8	81.0	 m
2.5	233.7														2.5
3	215.5														3
3.5	198.8	153.0													3.5
4	187.1	153.0	145.0												4
4.5	172.6	145.0	140.0												4.5
5	162.4	140.0	138.0	120.0											5
6	143.9	136.0	125.0	118.0	108.0										6
7	130.1	121.8	118.2	109.0	103.0	91.0									7
8	117.6	110.4	108.0	99.0	95.0	86.0	63.1								8
9	107.3	100.7	97.9	92.0	87.6	81.0	60.6	54.0							9
10	95.0	92.2	91.0	84.5	80.8	76.0	58.3	52.7	43.0						10
11	87.0	84.9	83.9	78.0	74.5	73.0	56.0	51.0	42.5	33.0					11
12	75.0	79.5	78.7	72.0	69.8	68.0	53.3	49.0	42.0	32.8	26.0				12
13	58.0	73.4	72.5	65.0	65.4	64.0	50.9	46.4	41.0	32.6	25.7	22.0			13
14		67.5	68.0	58.3	61.4	59.0	48.5	44.7	40.0	32.4	25.5	21.0			14
16		55.5	60.5	51.9	54.6	55.0	43.6	40.5	36.3	31.3	25.2	20.5	17.0	13.5	16
18		38.1	53.9	43.9	49.1	47.0	39.5	36.4	33.1	29.0	24.5	20.3	16.9	13.4	18
20			48.1	39.8	44.5	41.2	36.4	31.5	29.6	27.8	22.6	20.1	16.8	13.3	20
22				36.3	41.0	38.0	33.0	29.8	27.0	25.4	21.7	20.0	16.7	13.2	22
24				33.5	37.8	35.0	30.4	27.0	25.0	23.4	20.4	18.9	16.1	13.1	24
26				29.8	34.7	32.3	28.1	24.5	23.0	21.6	19.5	17.7	15.2	13.0	26
28				21.4	31.3	29.8	25.8	22.5	21.4	20.0	18.3	16.6	14.4	12.9	28
30					28.2	27.5	24.2	20.5	19.6	18.5	17.0	15.6	13.8	12.5	30
32					24.2	25.7	22.4	18.9	18.0	17.3	16.0	14.7	12.9	11.8	32
34						23.7	20.9	17.4	16.9	16.0	15.0	13.7	12.3	11.0	34
36						21.8	19.7	16.3	15.6	15.0	14.0	13.0	11.5	10.6	36
38						15.5	18.4	15.0	14.5	14.0	12.9	12.1	11.0	10.1	38
40							17.3	13.4	13.3	13.2	12.3	11.6	10.4	9.7	40
42							16.2	12.9	12.5	12.1	11.5	10.9	9.9	9.2	42
44								12.3	11.7	11.4	11.0	10.2	9.4	8.7	44
46								12.0	9.8	10.7	10.3	9.5	8.9	8.2	46
48									8.5	10.0	9.8	9.1	8.4	7.8	48
50									8.1	9.4	9.2	8.5	7.8	7.4	50
52									7.6	8.8	8.8	8.0	7.4	6.9	52
54										7.8	7.2	7.5	7.0	6.4	54
56										5.8	6.7	7.0	6.5	6.1	56
58											6.3	6.6	6.0	5.7	58
60												6.0	5.7	5.3	60
62												5.2	5.2	4.6	62
64												4.3	4.5	4.3	64
66													4.0	4.2	66
68													3.5	3.6	68
70														3.0	70
72														2.5	72
74														1.9	74
 m	28.0	12.0	12.0	10.0	9.0	7.0	5.0	5.0	4.0	3.0	2.0	2.0	2.0	2.0	 m
 m/s	14.5	14.5	13	11.3	11.3	11.3	11.3	11.3	11.3	11.3	11.3	11.3	11.3	11.3	 m/s

Remark

- * 100t standard counterweight + 20t optional counterweight.
- Ratings above are the rated lifting capacities when this crane is supported with the firm ground and stays in level.
- Ratings above are the maximum capacities of varied extending modes.
- The rated lifting capacities include the weight of hook block and riggings.
- Choose rated lifting capacity of the longer boom and radius when the actual boom length and radius are between two values in the charts.

1. *120t 需额外选配 20t 配重。







- 表中给定数值是在平整坚固的地面上，整机调平状态下起重机的额定起重量。
- 表中给定数值为对应臂长、取不同伸臂方式的最大值。
- 表中额定起重量包括起重主钩和吊具的重量。
- 如果实际幅度介于表上两个数字之间，取较大值决定作业的起重量。

Load Chart-T

性能表 - 主臂

Unit: t



	15.4	20.3	25.3	30.2	35.2	40.2	45.1	50.1	55.0	60.0	64.9	69.9	74.8	81.0	
2.5	233.7														2.5
3	211.2														3
3.5	198.8	153.0													3.5
4	183.4	153.0	145.0												4
4.5	169.1	145.0	140.0												4.5
5	159.2	140.0	138.0	120.0											5
6	141.0	136.0	125.0	118.0	108.0										6
7	127.5	121.8	118.2	109.0	103.0	91.0									7
8	115.2	110.4	108.0	99.0	95.0	86.0	63.1								8
9	105.6	100.7	97.9	92.0	87.6	81.0	60.6	54.0							9
10	95.0	92.2	91.0	84.5	80.8	76.0	58.3	52.7	43.0						10
11	87.0	84.9	83.9	78.0	74.5	73.0	56.0	51.0	42.5	33.0					11
12	75.0	79.5	78.7	72.0	69.8	68.0	53.3	49.0	42.0	32.8	26.0				12
13	58.0	73.4	72.5	65.0	65.4	64.0	50.9	46.4	41.0	32.6	25.7	22.0			13
14		67.5	68.0	58.3	61.4	59.0	48.5	44.7	40.0	32.4	25.5	21.0			14
16		55.5	59.5	51.9	54.6	55.0	43.6	40.5	36.3	31.3	25.2	20.5	17.0	13.5	16
18		38.1	51.3	43.9	49.1	47.0	39.5	36.4	33.1	29.0	24.5	20.3	16.9	13.4	18
20			44.7	39.8	44.5	41.2	36.4	31.5	29.6	27.8	22.6	20.1	16.8	13.3	20
22				36.3	39.5	38.0	33.0	29.8	27.0	25.4	21.7	20.0	16.7	13.2	22
24				33.5	35.1	35.0	30.4	27.0	25.0	23.4	20.4	18.9	16.1	13.1	24
26				29.8	31.3	32.3	28.1	24.5	23.0	21.6	19.5	17.7	15.2	13.0	26
28				21.4	28.2	29.2	25.8	22.5	21.4	20.0	18.3	16.6	14.4	12.9	28
30					25.4	26.5	24.2	20.5	19.6	18.5	17.0	15.6	13.8	12.5	30
32					23.0	24.0	22.4	18.9	18.0	17.3	16.0	14.7	12.9	11.8	32
34						21.8	20.9	17.4	16.9	16.0	15.0	13.7	12.3	11.0	34
36						19.7	19.7	16.3	15.6	15.0	14.0	13.0	11.5	10.6	36
38						15.5	18.4	15.0	14.5	14.0	12.9	12.1	11.0	10.1	38
40							17.3	13.4	13.3	13.2	12.3	11.6	10.4	9.7	40
42							16.2	12.9	12.5	12.1	11.5	10.9	9.9	9.2	42
44								12.3	11.7	11.4	11.0	10.2	9.4	8.7	44
46								12.0	9.8	10.7	10.3	9.5	8.9	8.2	46
48									8.5	10.0	9.8	9.1	8.4	7.8	48
50									8.1	9.4	9.2	8.5	7.8	7.4	50
52									7.6	8.8	8.5	8.0	7.4	6.9	52
54										7.8	7.2	7.5	7.0	6.4	54
56										5.8	6.7	7.0	6.5	6.1	56
58											6.3	6.6	6.0	5.7	58
60												6.0	5.7	5.3	60
62												5.2	5.2	4.6	62
64												4.3	4.5	4.3	64
66													4.0	4.2	66
68													3.5	3.6	68
70														3.0	70
72														2.5	72
74														1.9	74
	28	12	12	10	9	7	5	5	4	3	2	2	2	2	
	14.5	14.5	13.0	13.0	11.3	11.3	11.3	11.3	11.3	11.3	11.3	11.3	11.3	11.3	

Remark

1. Ratings above are the rated lifting capacities when this crane is supported with the firm ground and stays in level.
2. Ratings above are the maximum capacities of varied extending modes.
3. The rated lifting capacities include the weight of hook block and riggings.
4. Choose rated lifting capacity of the longer boom and radius when the actual boom length and radius are between two values in the charts.

1. 表中给定数值是在平整坚固的地面上，整机调平状态下起重机的额定起重量；
2. 表中给定数值为对应臂长、取不同伸臂方式的最大值；
3. 表中额定起重量包括起重主钩和吊具的重量；
4. 如果实际幅度介于表上两个数字之间，取较大值决定作业的起重量。

Operating Range - TS

起升高度曲线 - 主臂 + 超起

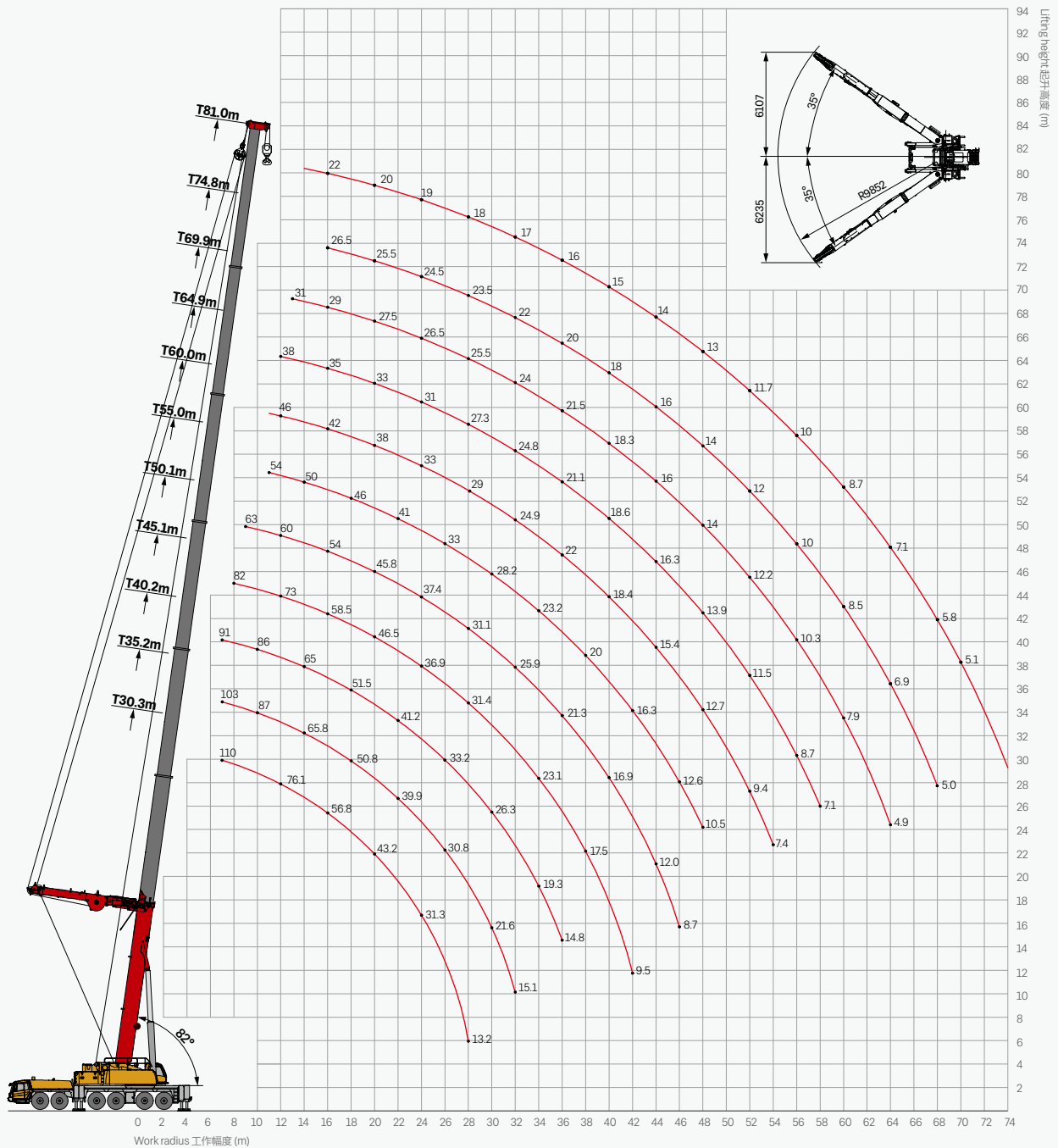

Load Chart - TS

性能表 - 主臂 + 超起

Unit: t

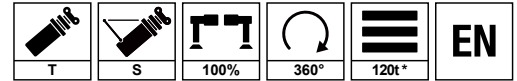

	30.2	35.2	40.2	45.1	50.1	55.0	60.0	64.9	69.9	74.8	81.0	
7	110.0	103.0	91.0									7
8	105.0	99.0	90.0	82.0								8
9	95.0	95.0	89.0	81.0	63.0							9
10	90.0	87.0	86.0	80.0	62.0	55.0						10
11	85.0	80.0	80.0	78.0	61.0	54.0	47.0					11
12	79.6	75.0	74.0	73.0	60.0	53.0	46.0	38.0				12
13	73.6	70.3	69.0	68.0	59.0	52.0	45.0	37.0	31.0			13
14	68.3	67.0	65.0	65.0	58.0	50.0	44.0	36.0	30.0			14
16	59.4	60.7	59.9	60.0	54.0	48.0	42.0	35.0	29.0	26.5	22.0	16
18	54.9	53.3	55.2	53.2	50.0	46.0	40.0	34.0	28.0	26.0	21.0	18
20	49.8	47.8	50.4	46.8	46.0	44.0	38.0	33.0	27.5	25.5	20.0	20
22	44.0	44.7	44.8	41.0	42.0	41.0	36.0	32.0	27.0	25.0	19.5	22
24	38.9	39.7	39.7	38.1	38.7	36.0	33.0	31.0	26.5	24.5	19.0	24
26	34.5	35.4	35.5	35.0	34.5	33.0	31.0	29.0	26.0	24.0	18.5	26
28	30.5	31.8	31.8	32.5	32.0	30.9	29.0	27.3	25.5	23.5	18.0	28
30		28.5	28.6	29.6	29.7	27.8	26.4	26.0	25.0	23.0	17.5	30
32		25.6	25.9	26.9	26.9	25.4	24.9	24.8	24.0	22.0	17.0	32
34			23.3	24.5	24.5	24.2	23.0	23.5	23.0	21.0	16.5	34
36			21.1	22.3	22.7	22.1	20.8	21.1	21.5	20.0	16.0	36
38				21.2	21.1	20.9	19.4	19.5	19.5	19.0	15.5	38
40				20.2	19.3	19.8	18.8	17.8	18.3	18.0	15.0	40
42				18.5	18.5	18.8	17.6	16.2	16.8	17.0	14.4	42
44					17.6	17.4	16.2	15.2	15.5	16.0	14.0	44
46					16.2	16.2	15.5	14.7	14.1	15.0	13.5	46
48						15.0	14.4	14.2	13.0	13.7	13.0	48
50							13.2	13.4	12.6	12.5	12.5	50
52							12.0	12.2	12.0	11.3	11.7	52
54							10.9	11.1	10.9	10.1	10.6	54
56								10.0	9.9	9.1	9.6	56
58								9.0	8.9	8.2	8.7	58
60									8.0	7.3	7.8	60
62									7.1	6.5	6.9	62
64									6.4	5.7	6.2	64
66										5.0	5.4	66
68										4.3	4.8	68
70											4.1	70
72											3.5	72
74											2.9	74
	9.0	8.0	7.0	7.0	5.0	5.0	4.0	3.0	3.0	3.0	2.0	
	13.0	11.3	11.3	11.3	11.3	11.3	11.3	11.3	11.3	11.3	11.3	

Remark

- * 100t standard counterweight + 20t optional counterweight.
- Ratings above are the rated lifting capacities when this crane is supported with the firm ground and stays in level.
- Ratings above are the maximum capacities of varied extending modes.
- The rated lifting capacities include the weight of hook block and riggings.
- Choose rated lifting capacity of the longer boom and radius when the actual boom length and radius are between two values in the charts.

1.*120t 需额外选配 20t 配重。





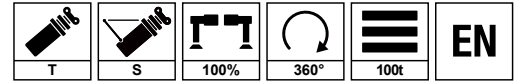

- 表中给定数值是在平整坚固的地面上，整机调平状态下起重机的额定起重量。
- 表中给定数值为对应臂长、取不同伸臂方式的最大值。
- 表中额定起重量包括起重主钩和吊具的重量。
- 如果实际幅度介于表上两个数字之间，取较大值决定作业的起重量。

Load Chart - TS

性能表 - 主臂 + 超起

Unit: t



 m	30.2	35.2	40.2	45.1	50.1	55.0	60.0	64.9	69.9	74.8	81.0	 m
7	110.0	103.0	91.0									7
8	105.0	99.0	90.0	82.0								8
9	95.0	95.0	89.0	81.0	63.0							9
10	90.0	87.0	86.0	80.0	62.0	55.0						10
11	85.0	80.0	80.0	78.0	61.0	54.0	47.0					11
12	78.3	75.0	74.0	73.0	60.0	53.0	46.0	38.0				12
13	72.4	70.3	69.0	68.0	59.0	52.0	45.0	37.0	31.0			13
14	67.0	67.0	65.0	65.0	58.0	50.0	44.0	36.0	30.0			14
16	59.0	58.3	59.9	58.0	54.0	48.0	42.0	35.0	29.0	26.5	22.0	16
18	52.8	51.2	53.4	52.0	50.0	46.0	40.0	34.0	28.0	26.0	21.0	18
20	45.8	46.5	46.5	45.0	45.5	44.0	38.0	33.0	27.5	25.5	20.0	20
22	40.0	42.0	40.8	41.0	39.9	39.9	36.0	32.0	27.0	25.0	19.5	22
24	35.3	37.6	36.1	36.0	35.5	35.2	33.0	31.0	26.5	24.5	19.0	24
26	31.1	33.6	32.1	33.2	33.2	31.2	31.0	29.0	26.0	24.0	18.5	26
28	27.4	30.1	29.2	30.0	29.7	27.9	28.4	27.3	25.5	23.5	18.0	28
30		26.9	26.9	26.8	26.8	26.5	25.1	25.8	25.0	23.0	17.5	30
32		22.6	24.3	24.1	24.6	23.7	23.0	22.8	23.6	22.0	17.0	32
34			21.5	23.0	22.4	22.4	22.0	20.1	21.0	21.0	16.5	34
36			18.1	21.1	20.7	21.4	19.6	18.0	18.6	19.8	16.0	36
38				19.0	19.6	19.3	17.8	16.9	16.5	17.7	15.5	38
40				17.1	17.7	17.5	16.7	16.3	15.5	15.8	15.0	40
42				15.3	15.9	15.8	15.0	15.1	14.7	14.1	14.4	42
44					14.4	14.3	13.5	13.6	13.4	12.6	13.1	44
46					12.9	12.8	12.1	12.2	12.1	11.3	11.7	46
48						11.6	10.8	11.0	10.8	10.0	10.5	48
50							9.6	9.8	9.6	9.0	9.3	50
52							8.6	8.8	8.6	7.9	8.3	52
54							7.5	7.8	7.6	6.9	7.4	54
56								6.9	6.7	6.0	6.4	56
58								6.0	5.8	5.2	5.6	58
60									5.1	4.4	4.9	60
62									4.3	3.7	4.1	62
64									3.7	3.0	3.5	64
66										2.3	2.8	66
68										1.7	2.2	68
70											1.6	70
72												72
74												74
 m	9.0	8.0	7.0	7.0	5.0	5.0	4.0	3.0	3.0	3.0	2.0	 m
 m/s	13.0	11.3	11.3	11.3	11.3	11.3	11.3	11.3	11.3	11.3	11.3	 m/s

Remark

1. Ratings above are the rated lifting capacities when this crane is supported with the firm ground and stays in level.
2. Ratings above are the maximum capacities of varied extending modes.
3. The rated lifting capacities include the weight of hook block and riggings.
4. Choose rated lifting capacity of the longer boom and radius when the actual boom length and radius are between two values in the charts.

1. 表中给定数值是在平整坚固的地面上，整机调平状态下起重机的额定起重量；
2. 表中给定数值为对应臂长、取不同伸臂方式的最大值；
3. 表中额定起重量包括起重主钩和吊具的重量；
4. 如果实际幅度介于表上两个数字之间，取较大值决定作业的起重量。

Operating Range - TJ

起升高度曲线 - 主臂 + 副臂

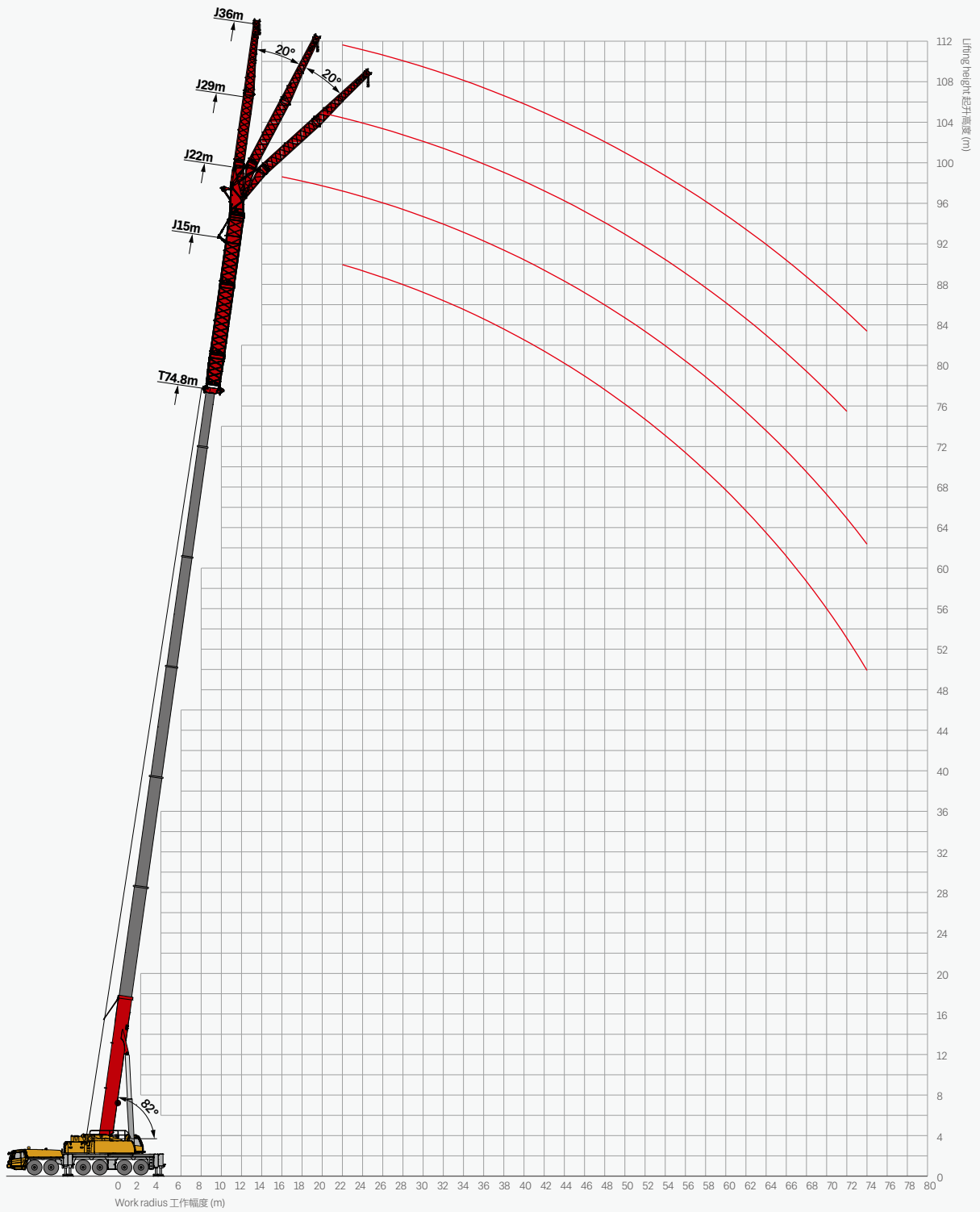

Load Chart - TJ

性能表 - 主臂 + 副臂

Unit: t

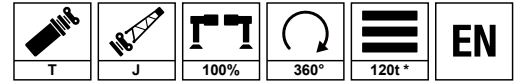

Lift Height m	69.9m				74.8m				Lift Height m
	15m	22m	29m	36m	15m	22m	29m	36m	
16		7.2							16
18		7.1				5.8			18
20		7.0	5.3			5.7			20
22	9.7	6.9	5.1	4.0	8.6	5.6	4.2		22
24	9.8	6.8	5.0	4.0	8.4	5.5	4.1	3.1	24
26	9.6	6.7	4.9	3.9	8.2	5.4	4.0	3.1	26
28	9.4	6.6	4.8	3.9	8.0	5.3	3.9	3.1	28
30	9.1	6.4	4.7	3.8	7.7	5.2	3.8	3.0	30
32	8.8	6.2	4.6	3.8	7.6	5.1	3.7	3.0	32
34	8.5	6.0	4.5	3.7	7.6	4.9	3.6	2.9	34
36	8.2	5.9	4.4	3.7	6.6	4.8	3.5	2.9	36
38	7.8	5.7	4.3	3.6	6.6	4.7	3.4	2.9	38
40	7.5	5.6	4.2	3.6	6.6	4.6	3.3	2.8	40
42	7.3	5.4	4.1	3.5	6.4	4.5	3.2	2.8	42
44	7.1	5.3	4.0	3.5	6.2	4.3	3.1	2.7	44
46	6.9	5.1	3.9	3.4	5.9	4.1	3.0	2.7	46
48	6.7	5.0	3.8	3.3	5.7	4.0	2.9	2.6	48
50	6.0	4.6	3.4	3.2	5.4	3.9	2.8	2.5	50
52	5.0	4.0	3.0	3.1	4.8	3.8	2.7	2.2	52
54	4.3	3.4	2.6	3.0	4.0	3.5	2.6	1.9	54
56	3.9	3.1	2.4	2.9	3.5	3.1	2.5	1.8	56
58	3.5	2.8	2.2	2.5	3.3	2.5	2.4	1.7	58
60	3.2	2.6	2.1	2.0	3.0	2.3	2.1	1.6	60
62	2.9	2.3	1.9	1.8	2.7	2.2	1.8	1.5	62
64	2.6	2.1	1.8	1.7	2.4	1.9	1.7	1.4	64
66	2.2	1.8	1.6	1.5	2.2	1.8	1.6	1.4	66
68	1.9	1.6	1.6	1.5	1.8	1.6	1.6	1.3	68
70	1.5	1.4	1.6	1.4	1.4	1.4		1.3	70
72	1.1	1.1	1.5	1.3	1.2	1.1		1.3	72
74	0.9	0.9		1.3	1.0	1.1		1.3	74
	1								
	1								

Remark

- * 100t standard counterweight + 20t optional counterweight.
- Ratings above are the rated lifting capacities when this crane is supported with the firm ground and stays in level.
- Ratings above are the maximum capacities of varied extending modes.
- The rated lifting capacities include the weight of hook block and riggings.
- Choose rated lifting capacity of the longer boom and radius when the actual boom length and radius are between two values in the charts.

- *120t 需额外选配 20t 配重。
- 表中给定数值是在平整坚固的地面上，整机调平状态下起重机的额定起重量。
- 表中给定数值为对应臂长、取不同伸臂方式的最大值。
- 表中额定起重量包括起重主钩和吊具的重量。
- 如果实际幅度介于表上两个数字之间，取较大值决定作业的起重量。

Load Chart - TJ

性能表 - 主臂 + 副臂

Unit: t

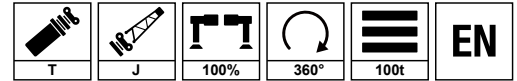

m	69.9m				74.8m				m
	15m	22m	29m	36m	15m	22m	29m	36m	
16		7.2							16
18		7.1				5.8			18
20		7.0	5.3			5.7			20
22	9.7	6.9	5.1	4.0	8.6	5.6	4.2		22
24	9.8	6.8	5.0	4.0	8.4	5.5	4.1	3.1	24
26	9.6	6.7	4.9	3.9	8.2	5.4	4.0	3.1	26
28	9.4	6.6	4.8	3.9	8.0	5.3	3.9	3.1	28
30	9.1	6.4	4.7	3.8	7.7	5.2	3.8	3.0	30
32	8.8	6.2	4.6	3.8	7.6	5.1	3.7	3.0	32
34	8.5	6.0	4.5	3.7	7.6	4.9	3.6	2.9	34
36	8.2	5.9	4.4	3.7	6.6	4.8	3.5	2.9	36
38	7.8	5.7	4.3	3.6	6.6	4.7	3.4	2.9	38
40	7.5	5.6	4.2	3.6	6.6	4.6	3.3	2.8	40
42	7.3	5.4	4.1	3.5	6.4	4.5	3.2	2.8	42
44	7.1	5.3	4.0	3.5	6.2	4.3	3.1	2.7	44
46	6.9	5.1	3.9	3.4	5.9	4.1	3.0	2.7	46
48	6.7	5.0	3.8	3.3	5.7	4.0	2.9	2.6	48
50	6.0	4.6	3.4	3.2	5.4	3.9	2.8	2.5	50
52	5.0	4.0	3.0	3.1	4.8	3.8	2.7	2.2	52
54	4.3	3.4	2.6	3.0	4.0	3.5	2.6	1.9	54
56	3.9	3.1	2.4	2.9	3.5	3.1	2.5	1.8	56
58	3.5	2.8	2.2	2.5	3.3	2.5	2.4	1.7	58
60	3.2	2.6	2.1	2.0	3.0	2.3	2.1	1.6	60
62	2.9	2.3	1.9	1.8	2.7	2.2	1.8	1.5	62
64	2.6	2.1	1.8	1.7	2.4	1.9	1.7	1.4	64
66	2.2	1.8	1.6	1.5	2.2	1.8	1.6	1.4	66
68	1.9	1.6	1.6	1.5	1.8	1.6	1.6	1.3	68
70	1.5	1.4	1.6	1.4	1.4	1.4		1.3	70
72	1.1	1.1	1.5	1.3	1.2	1.1		1.3	72
74	0.9	0.9		1.3	1.0	1.1		1.3	74
	1								
	1								

Remark

1. Ratings above are the rated lifting capacities when this crane is supported with the firm ground and stays in level.
2. Ratings above are the maximum capacities of varied extending modes.
3. The rated lifting capacities include the weight of hook block and riggings.
4. Choose rated lifting capacity of the longer boom and radius when the actual boom length and radius are between two values in the charts.

1. 表中给定数值是在平整坚固的地面上，整机调平状态下起重机的额定起重量；
2. 表中给定数值为对应臂长、取不同伸臂方式的最大值；
3. 表中额定起重量包括起重主钩和吊具的重量；
4. 如果实际幅度介于表上两个数字之间，取较大值决定作业的起重量。

Operating Range - TSJ

起升高度曲线 - 主臂 + 超起 + 副臂

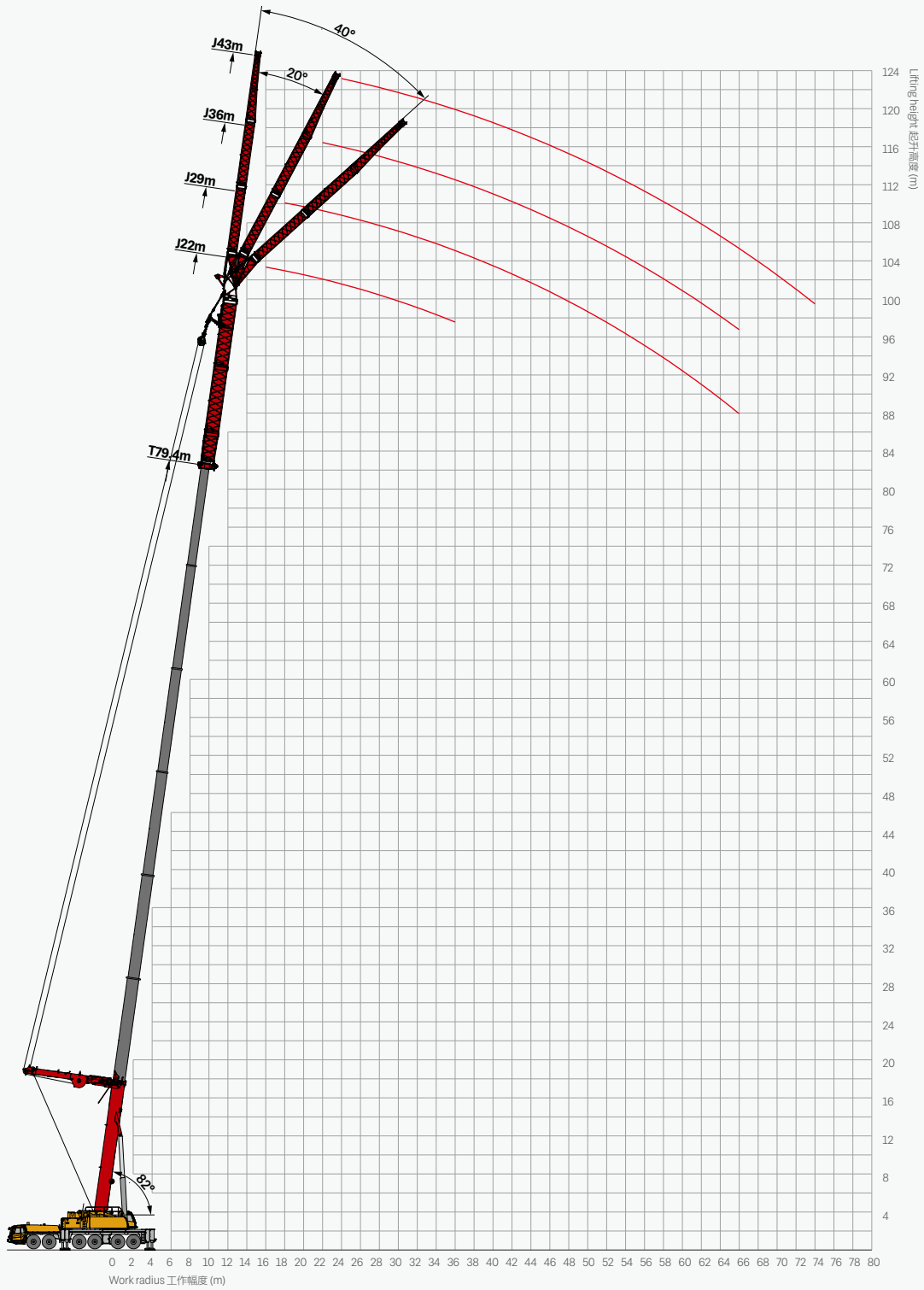

Load Chart - TSJ

性能表 - 主臂 + 超起 + 副臂

Unit: t

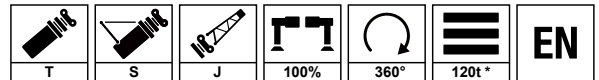

Lift Height m	64.9m				69.9m				74.8m				79m				Lift Height m
	22m	29m	36m	43m	22m	29m	36m	43m	22m	29m	36m	43m	22m	29m	36m	43m	
14	21.1				19.9												14
16	20.2	14.6			19.0	13.5			17.8	13.2			15.6				16
18	19.3	14.6			18.4	13.5			16.8	13.2			14.4	11.5			18
20	18.3	14.0	10.2		17.6	12.9	9.4		15.7	12.6	9.2		12.7	11.2			20
22	17.4	13.6	9.5	7.6	16.8	12.5	8.8	7.0	15.3	12.3	8.6	6.9	12.1	11.0	7.6		22
24	16.8	13.2	8.9	7.6	16.1	12.2	8.2	7.0	14.8	12.0	8.0	6.9	11.5	10.5	7.6	5.5	24
26	15.9	12.7	8.3	7.2	15.4	11.7	7.6	6.7	14.1	11.5	7.5	6.6	11.0	10.3	7.3	5.5	26
28	15.3	12.1	7.6	7.0	14.5	11.1	7.0	6.4	13.7	10.9	6.9	6.3	10.5	10.0	6.9	5.4	28
30	14.4	11.4	7.4	6.7	13.9	10.5	6.8	6.2	13.1	10.3	6.7	6.1	10.2	9.7	6.6	5.3	30
32	13.8	10.8	7.1	6.5	13.4	10.0	6.6	6.0	12.6	9.8	6.4	5.9	9.8	9.3	6.3	5.2	32
34	13.3	10.2	6.9	6.4	12.9	9.4	6.3	5.9	12.1	9.2	6.2	5.7	9.5	9.1	6.1	5.1	34
36	12.5	9.5	6.6	6.1	12.5	8.8	6.1	5.6	11.6	8.6	6.0	5.5	9.2	8.9	5.9	5.0	36
38	11.6	8.9	6.4	6.0	11.9	8.2	5.9	5.5	11.0	8.0	5.7	5.4	9.0	8.7	5.8	4.7	38
40	10.3	8.3	6.0	5.6	10.7	7.6	5.5	5.2	10.0	7.5	5.4	5.1	8.8	8.1	5.5	4.6	40
42	9.2	7.6	5.7	5.1	9.6	7.0	5.3	4.7	9.0	6.9	5.2	4.6	8.2	7.6	5.4	4.5	42
44	8.3	7.1	5.3	4.7	8.6	6.6	4.9	4.3	8.0	6.4	4.8	4.3	7.5	7.0	5.1	4.4	44
46	7.3	6.6	5.1	4.3	7.7	6.1	4.7	4.0	7.1	6.0	4.6	3.9	6.8	6.3	4.6	4.2	46
48	6.5	6.4	4.8	4.1	6.7	5.9	4.5	3.7	6.3	5.7	4.4	3.7	6.1	5.8	4.3	3.9	48
50	5.7	5.7	4.6	3.8	6.1	5.3	4.2	3.5	5.6	5.2	4.1	3.4	5.4	5.2	4.0	3.7	50
52	5.0	5.1	4.3	3.7	5.3	4.7	4.0	3.4	4.9	4.6	3.9	3.3	4.7	4.6	3.8	3.6	52
54	4.3	4.3	4.1	3.4	4.7	4.0	3.7	3.2	4.4	3.9	3.7	3.1	4.0	4.3	3.6	3.5	54
56	3.7	3.8	3.8	3.2	4.0	3.5	3.5	2.9	3.8	3.4	3.4	2.9	3.5	3.9	3.3	3.2	56
58	3.2	3.2	3.4	3.0	3.4	2.9	3.2	2.8	3.2	2.9	3.1	2.8	2.9	3.5	3.1	3.1	58
60	2.8	2.8	3.2	2.9	3.1	2.6	2.9	2.7	3.0	2.5	2.9	2.6	2.7	3.1	2.9	2.9	60
62	2.6	2.4	2.9	2.9	2.9	2.2	2.7	2.7	2.8	2.2	2.6	2.6	2.5	2.9	2.8	2.8	62
64	2.4	2.2	2.7	2.8	2.6	2.0	2.5	2.6	2.5	2.0	2.4	2.5	2.4	2.5	2.7	2.7	64
66	2.2		2.6	2.8	2.4		2.3	2.6	2.3		2.3	2.5	2.0	2.3	2.5	2.5	66
68			2.4	2.7	2.2		2.2	2.5	2.2		2.2	2.4				2.4	68
70			2.3	2.6			2.1	2.4			2.1	2.4				2.3	70
72				2.5				2.4				2.3				2.2	72
74				2.5				2.3				2.3				2.1	74
	1																
	1																

Remark

- * 100t standard counterweight + 20t optional counterweight.
- Ratings above are the rated lifting capacities when this crane is supported with the firm ground and stays in level.
- Ratings above are the maximum capacities of varied extending modes.
- The rated lifting capacities include the weight of hook block and riggings.
- Choose rated lifting capacity of the longer boom and radius when the actual boom length and radius are between two values in the charts.

1.*120t 需额外选配 20t 配重。

- 表中给定数值是在平整坚固的地面上，整机调平状态下起重机的额定起重量。
- 表中给定数值为对应臂长、取不同伸臂方式的最大值。
- 表中额定起重量包括起重主钩和吊具的重量。
- 如果实际幅度介于表上两个数字之间，取较大值决定作业的起重量。

Load Chart - TSJ

性能表 - 主臂 + 超起 + 副臂

Unit: t

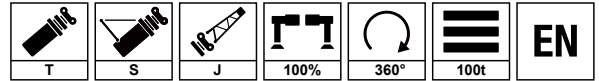

Lift height m	64.9m				69.9m				74.8m				79m				Lift height m
	22m	29m	36m	43m	22m	29m	36m	43m	22m	29m	36m	43m	22m	29m	36m	43m	
14	21.1				19.9												14
16	20.2	14.6			19.0	13.5			17.8	13.2			15.6				16
18	19.3	14.6			18.4	13.5			16.8	13.2			14.4	11.5			18
20	18.3	14.0	10.2		17.6	12.9	9.4		15.7	12.6	9.2		12.7	11.2			20
22	17.4	13.6	9.5	7.6	16.8	12.5	8.8	7.0	15.3	12.3	8.6	6.9	12.1	11.0	7.6		22
24	16.8	13.2	8.9	7.6	16.1	12.2	8.2	7.0	14.8	12.0	8.0	6.9	11.5	10.5	7.6	5.5	24
26	15.9	12.7	8.3	7.2	15.4	11.7	7.6	6.7	14.1	11.5	7.5	6.6	11.0	10.3	7.3	5.5	26
28	15.3	12.1	7.6	7.0	14.5	11.1	7.0	6.4	13.7	10.9	6.9	6.3	10.5	10.0	6.9	5.4	28
30	14.4	11.4	7.4	6.7	13.9	10.5	6.8	6.2	13.1	10.3	6.7	6.1	10.2	9.7	6.6	5.3	30
32	13.8	10.8	7.1	6.5	13.4	10.0	6.6	6.0	12.6	9.8	6.4	5.9	9.8	9.3	6.3	5.2	32
34	13.3	10.2	6.9	6.4	12.9	9.4	6.3	5.9	12.1	9.2	6.2	5.7	9.5	9.1	6.1	5.1	34
36	12.5	9.5	6.6	6.1	12.5	8.8	6.1	5.6	11.6	8.6	6.0	5.5	9.2	8.9	5.9	5.0	36
38	11.6	8.9	6.4	6.0	11.9	8.2	5.9	5.5	11.0	8.0	5.7	5.4	9.0	8.7	5.8	4.7	38
40	10.3	8.3	6.0	5.6	10.7	7.6	5.5	5.2	10.0	7.5	5.4	5.1	8.8	8.1	5.5	4.6	40
42	9.2	7.6	5.7	5.1	9.6	7.0	5.3	4.7	9.0	6.9	5.2	4.6	8.2	7.6	5.4	4.5	42
44	8.3	7.1	5.3	4.7	8.6	6.6	4.9	4.3	8.0	6.4	4.8	4.3	7.5	7.0	5.1	4.4	44
46	7.3	6.6	5.1	4.3	7.7	6.1	4.7	4.0	7.1	6.0	4.6	3.9	6.8	6.3	4.6	4.2	46
48	6.5	6.4	4.8	4.1	6.7	5.9	4.5	3.7	6.3	5.7	4.4	3.7	6.1	5.8	4.3	3.9	48
50	5.7	5.7	4.6	3.8	6.1	5.3	4.2	3.5	5.6	5.2	4.1	3.4	5.4	5.2	4.0	3.7	50
52	5.0	5.1	4.3	3.7	5.3	4.7	4.0	3.4	4.9	4.6	3.9	3.3	4.7	4.6	3.8	3.6	52
54	4.3	4.3	4.1	3.4	4.7	4.0	3.7	3.2	4.4	3.9	3.7	3.1	4.0	4.3	3.6	3.5	54
56	3.7	3.8	3.8	3.2	4.0	3.5	3.5	2.9	3.8	3.4	3.4	2.9	3.5	3.9	3.3	3.2	56
58	3.2	3.2	3.4	3.0	3.4	2.9	3.2	2.8	3.2	2.9	3.1	2.8	2.9	3.5	3.1	3.1	58
60	2.8	2.8	3.2	2.9	3.1	2.6	2.9	2.7	3.0	2.5	2.9	2.6	2.7	3.1	2.9	2.9	60
62	2.6	2.4	2.9	2.8	2.9	2.2	2.7	2.6	2.8	2.2	2.6	2.6	2.5	2.9	2.8	2.8	62
64	2.4	2.2	2.7	2.8	2.6	2.0	2.5	2.6	2.5	2.0	2.4	2.5	2.4	2.5	2.7	2.7	64
66	2.2		2.6	2.7	2.4		2.3	2.5	2.3		2.3	2.5	2.0	2.3	2.5	2.5	66
68			2.4	2.6	2.2		2.2	2.5	2.2		2.2	2.4				2.4	68
70			2.3	2.6			2.1	2.4			2.1	2.4				2.3	70
72				2.5				2.4				2.3				2.2	72
74				2.5				2.3				2.3				2.1	74
	1																
	1																

Remark

1. Ratings above are the rated lifting capacities when this crane is supported with the firm ground and stays in level.
2. Ratings above are the maximum capacities of varied extending modes.
3. The rated lifting capacities include the weight of hook block and riggings.
4. Choose rated lifting capacity of the longer boom and radius when the actual boom length and radius are between two values in the charts.

1. 表中给定数值是在平整坚固的地面上，整机调平状态下起重机的额定起重量。
2. 表中给定数值为对应臂长、取不同伸臂方式的最大值。
3. 表中额定起重量包括起重主钩和吊具的重量。
4. 如果实际幅度介于表上两个数字之间，取较大值决定作业的起重量。



SANY GROUP CRANE BU

SANY Mobile Crane Industrial Park, No.168 Jinzhou Avenue, Jinzhou Development Zone, Changsha City,
Hunan Province, P.R. China Zip 410600
Consulting sanycrane@sanygroup.com (Crane BU) / crd@sany.com.cn (IHQ)
After-sales Service 0086-400 6098 318

Reminder:

Any change in the technical parameters and configuration due to product modification or upgrade may occur without prior notice.
The machine in the picture may include additional equipment. This brochure is for reference only, and goods in kind shall prevail.
Copyright at SANY. No part of this brochure may be copied or used for any purpose without written approval from SANY.

© Edited in December 2023

三一集团起重事业部

中国湖南长沙金洲开发区金洲大道 168 号 三一汽车起重机产业园 邮编: 410600
咨询: sanycrane@sanygroup.com (起重事业部) / crd@sany.com.cn (国际总部)
海外售后服务: 0086-400 6098 318

温馨提示:

由于技术不断更新, 技术参数及配置如有更改, 恕不另行通知。图中机器可能包括附加设备, 本画册仅供参考, 以实物为准。
版权为三一所有, 未经三一书面许可, 本画册任何内容不得被复制用于任何目的。

© 2023 年 12 月版

