

SANY[®]

SPECIFICATION



600t



95m



126.5m

SAC6000C8-8

SANY ALL TERRAIN CRANE

QUALITY CHANGES THE WORLD

www.sanyglobal.com

It is one of the core business units in SANY Group, specializing in the development and manufacturing of high-end wheel cranes, crawler cranes and tower cranes, including the complete range of wheel cranes from 8 to 2400t, crawler cranes from 25 to 4500t and tower cranes from 6 to 185t.



SANY CRANE



SANY ALL TERRAIN CRANE SAC6000C8-8 / 600T LIFTING CAPACITY



**6 axle
carrier**

**Double
engine
system**

**8 section
95m boom**

**48m fixed
jib (hydraulic
adjustment)**

**Self-assembly
lattice superlift
device**



**84m luffing
jib (optional)**

**143t
counterweight**

**505
tires**

**Heavy-duty
axles**

**New
generation cab**

Strong lifting capacity

- Main boom – 8 section U shape profile, full extension 95m.
- Fixed jib – variable lengths from 12m to 48m, offsetable at 0°/20°/40°.
- Superlift device - self assembly and disassembly without the need of auxiliary crane, lifting capacities more than doubled at long boom.

Excellent driving performance

- Innovative 6-axle reinforced chassis, all-wheel steering and 4-axle drive, and a variety of steering and drive modes bring enhanced driving flexibility.
- The new intelligent multi-mode hydro-pneumatic suspension functions real-time vehicle attitude monitoring, active lifting and variable damping adaptation, etc., making driving more comfortable and stable.
- With a strong power and transmission system equipped with hydraulic torque converter and hydraulic retarder, the driving safety and smoothness are greatly improved.
- Standard heavy-duty axles and 505 tires increase jobsite transfer efficiency significantly. Jobsite driving speed with superlift device reaches 40km/h, with boom and outriggers non-limit.



**SANY ALL TERRAIN CRANE
SAC6000C8-8 / 600T LIFTING CAPACITY**

High efficiency and reliability

- Multi-pump and multi-circuit hydraulic system, electro proportional and multi-level pressure control to realize speed grading and inching mobility, achieving better performance.
- The new superlift stable tensioning control technology, one click auto tensioning and swing away/back, improves the operation efficiency by 20% and the lifting performance of medium and long boom by 5%-10%. The active adjustment technology against side-bending is applied on the superlift to ensure long boom operation safety.
- Less operational constraints thanks to multi-mode superlift conditions, three outrigger span combinations, and three counterweight slewing radii, more suitable for working in constricted areas.

High level safety

- The multifunctional wireless remote control system improves operation ease and safety.
- The anti-tipping early-warning system, the safety protection program and fault diagnosis system further enhances safety.
- The load moment indicator system with high precision, high stability and high intelligence is adopted to protect the lifting operation in an all-round way.
- Equipped with adequate sensors for timely data feedback, real-time monitoring, the operator has access to the working data at any time.



Overall Dimensions

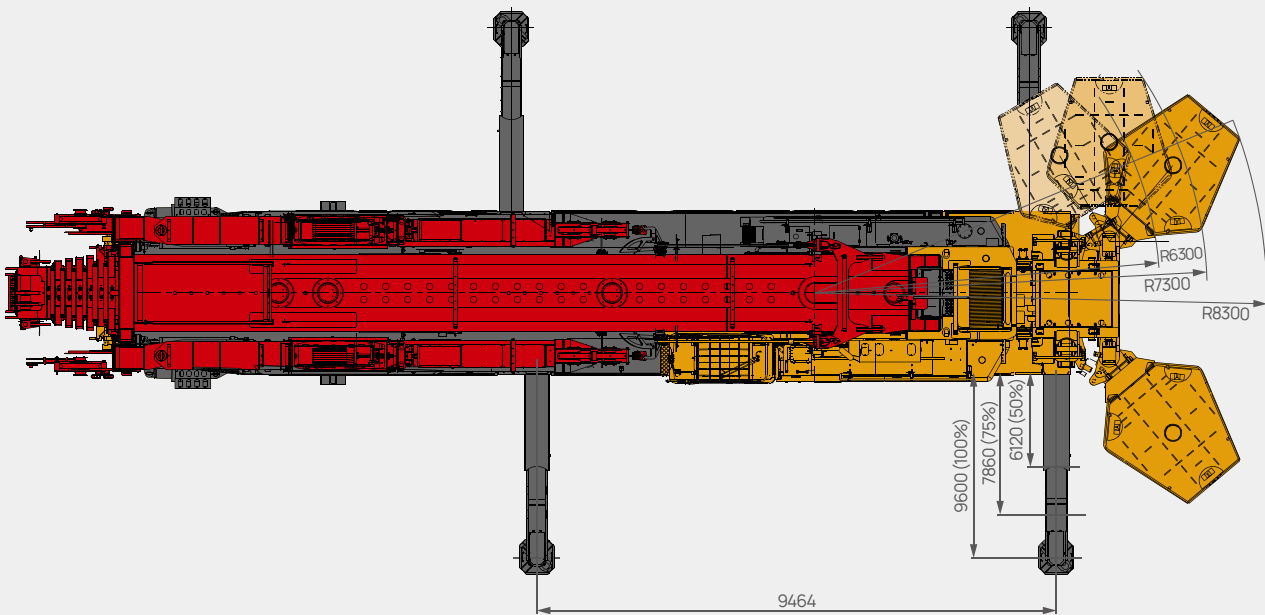
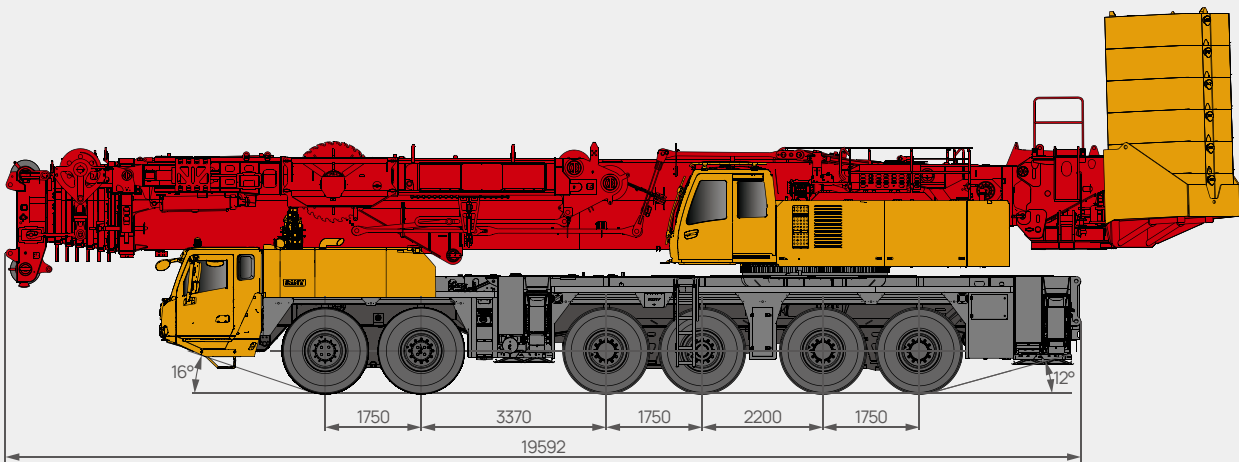

Technical Specification

CATEGORY	ITEM	UNIT	VALUE	
CAPACITY	Max. lifting capacity	t	600	
WEIGHT	Gross weight	kg	72000 (excl. boom sections 2-8, rear outriggers)	
POWER (CHASSIS)	Weichai	Max. engine power	kW/rpm	485/1800
		Max. engine torque	N·m/rpm	3200/(900~1400)
	Benz (optional)	Max. engine power	kW/rpm	480/1800
		Max. engine torque	N·m/rpm	3100/1100 (Euro V) & 3100/1300 (Euro 3A)
POWER (SUPERSTRUCTURE)	Weichai	Max. engine power	kW/rpm	221/2200
		Max. engine torque	N·m/rpm	1200/(1400~1600)
	Benz (optional)	Max. engine power	kW/rpm	205/2200
		Max. engine torque	N·m/rpm	1100/(1200~1600)
DIMENSIONS	Overall length	mm	17745	
	Overall width	mm	3000	
	Overall height	mm	4000	
TRAVEL	Max.travel speed	km/h	70	
	Min.steering radius	m	12	
	Wheel formula	-	12 × 8 × 12	
	Min.ground clearance	mm	355	
	Approach angle	°	16	
	Departure angle	°	12	
	Max.gradeability	-	44%	
	Fuel consumption per 100km	L	≤ 112	
MAIN PERFORMANCE	Working temperature range	°C	-20~+40	
	Min.rated lifting radius	m	3	
	Boom sections (Qty.)	-	8	
	Boom shape	-	U shape	
	Max.lifting moment	Basic boom	t·m	1500
	Boom length	Basic boom	m	16.4
		Full-extension boom	m	95
		Max. combination of boom + fixed jib	m	126.5 (78.5+48)
		Max. combination of boom + luffing jib	m	148.8 (57.8+7+84)
	Outrigger span (Longitudinal × Transverse)	m	9.4 × 9.6	
Jib offset	°	0, 20, 40		
AIRCONDITIONER	in operator's cab	-	Heating & Cooling	
	in driver's cab	-	Heating & Cooling	

Technical Specification



Hook

Rated load/t		Number of sheaves	Rope rate	Hook weight/kg
200	<input type="radio"/>	9	18	2440
160	<input checked="" type="radio"/>	7	14	1627
80	<input type="radio"/>	3	7	723
32	<input type="radio"/>	1	3	521
12.5	<input type="radio"/>	0	1	526

● Standard ○ Optional



Operations

Item		Max. single rope lifting speed (the 4th layer)	Rope diameter/length	Max. single line pull
Main winch		130m/min	Φ24mm/640m	13.3t
Slewing		0-1.2r/min		
Luffing up/down		95s/95s		
Boom extending		1150s		
Outrigger jack	Extension	50s		
	Retraction	50s		
Outrigger beam	Extension	50s		
	Retraction	55s		

Crane Introduction

Carrier

Driver's cab

- The new generation cab is a new type of steel structure independently developed by SANY, with excellent shock absorption and sealing performance. With outward opening doors on both sides, the cab is equipped with driver's seat and passenger's seat with pneumatic suspension, adjustable steering wheel, large-field rearview mirrors, comfortable driver's seat with headrest, anti-fog fan, heating and cooling A/C, and stereo radio, etc., as well as complete control instruments and meters, so that is the driving will be more comfortable, safer, and more user-friendly.

Carrier frame

- Designed and manufactured by SANY, the torsion-resistant box-type structure with optimized structure and low weight is welded by fine-grained high-strength steel plates. The outriggers are retracted in special fixed boxes, which are located between axle 2 and axle 3 and at the carrier frame tail, and equipped with front and rear towing devices.

Chassis engine

Weichai

- Model: Weichai WP15H660E61, electronically controlled, in-line 6-cylinder, watercooled, supercharged, intercooled, electronic injection diesel engine.
- Power: 485kW / 1800rpm.
- Torque: 3200N·m / (900-1400)rpm.
- Emission standard: China National VI.
- Fuel reservoir capacity: approx. 600L.

Benz (optional)

- Model: Benz 473, electronically controlled, in-line 6-cylinder, watercooled, supercharged, intercooled, electronic injection diesel engine.
- Power: 480kW / 1800rpm.
- Torque: 3100N·m / 1100rpm, 3100N·m / 1300rpm
- Emission standard: Euro V or Euro 3A.
- Fuel reservoir capacity: approx. 600L.

Transmission

- ZF auto transmission, with integral hydraulic retarder for wear-free brake, features a wide range of speed ratio with 12 forward speeds and 2 reversing speeds, which is adaptable to slope climbing and high-speed traveling on public roads.

Steering

- All new constant pressure and constant flow steering system featuring linear following without lag and precise steering angle. Three steering emergency systems available. The steering mode is adjusted according to the speed.
- Six steering modes: 1) on-road driving (default); 2) all wheel steering; 3) crab steering; 4) reduced swing out steering; 5) independent rear axle steering; 6) independent front axle steering.

Axle

- Hande high quality heavy-duty axles, with all axles steered, and axles 1, 3, 5, 6 are driven. Axles 1, 2 adopt hydraulic power steering system with linkage feedback, and axles 3-6 adopt electrohydraulic control steering, with assist for speed control and selectable special steering mode, for easy steering and flexible operation. Optional Kessler axle.

Suspension system

- Multi-mode height adjustable hydro-pneumatic suspension system with hydraulic lockout, which can realize five modes incl. suspension, rigid locking, auto leveling, whole vehicle rising and single point rising & lowering. It can conduct real-time monitoring of vehicle attitude, smart identifying of axle load, active rising and self-adaptability to tough terrains, ensuring smoothness and lateral stability during driving.

Tires

- 12 tires - 18.00R25 (505/95 R25).

Wheel formula

- 12 × 8 × 12.

Outrigger

- H-type two-stage telescopic outriggers. The telescopic hydraulic system of outrigger adopts electric proportional control technology and is equipped with wireless remote control featuring high precision and easy operation, and has the function of automatic leveling.

Brake

- Dual circuit, air brake, disc brakes available.
- Service brake: air servo brakes on all wheels, dual circuits, all wheels equipped with disc brakes.
- Parking brake: actuated by pressure accumulators on axles 2 to 6.
- Assist brake: engine brake and exhaust brake, transmission hydraulic retarder brake.

Electrical system

- 24 V DC power supply. Chassis power supply can be cut off; equipped with auto lighting system; actions of the vehicle such as throttle and outrigger control are realized by electrical control with easy and fast operation; the electrical system has strong detection, logic, operation and other capabilities, and has the functions of fault diagnosis, centralized display and self-protection.
- The chassis adopts CAN bus system, which is provided with: fast, stable and accurate data transmission; multi-functional centralized display system; high protection grade of IP65; low power consumption with a maximum of 5W; with four function keys provided in the user interface; LCD is used for display adjustable for contrast.

Crane Introduction

Superstructure



Operator's cab

- New generation cab, 0~20° tiltable. It adopts corrosion resistant steel plate, full coverage softened interior, panoramic sunroof, adjustable seat, making the operation comfortable and easy. Main and auxiliary touch screens are applied, realizing perfect combination of main console and operation display system. All the operation data are displayed clearly. The screen features adjustable viewing angle, multi-image and multi-angle monitoring and one-key operation. The main boom, luffing jib and superlift winch are equipped with cameras for centralized monitoring. Man-machine interaction is responsive and easy. Heating and cooling A/C is provided.



Superstructure engine

Weichai

- Model: Weichai WP7G300E473 , electronically controlled, in-line six-cylinder, watercooled, supercharged intercooled diesel engine.
- Power: 221kW / 2200rpm.
- Torque: 1200N·m / (1400~1600)rpm.
- Emission standard: Stage IV.
- Fuel reservoir capacity: 335L.

Benz (optional)

- Model: Benz OM906LA.E3A/1, electronically controlled, in-line sixcylinder, watercooled, supercharged intercooled diesel engine.
- Power: 205kW / 2200rpm.
- Torque: 1100N·m / (1200~1600)rpm.
- Emission standard: Euro III.
- Fuel reservoir capacity: 330L.



Slewing platform

- Designed and manufactured by SANY, the turntable made by fine-grained highstrength steel has a better structure.



Boom & telescoping system

- Main boom: It is composed of 1 base boom and 7 telescopic sections. It is made of fine-grained high-strength steel plates by bending and welding, with U shape profile, it has good buckling resistance; the single cylinder automatic pinning system is adopted, and a double-acting cylinder can control the extension and retraction of all booms to achieve a combination of multiple boom lengths; the basic boom length is 16.4m and the full extension boom length is 95m.
- Fixed jib: There are the adapter, jib head, 6m and 12m large (small) cross-area inserts, which can realize the jib length combination of 12m~48m. The offset can be changed according to the actual needs of working conditions to improve the automation level, reduce the labor intensity and improve the work efficiency.
- Luffing jib: variable combinations of 18m~84m, significantly enhancing lifting capabilities and range.
- Superlift device: It's arranged on the left and right sides of the head of the base boom, and independent from each other, and it can realize assembly and disassembly without auxiliary crane. The superlift device can greatly improve the stress state of the boom, avoid side bending and reduce the downward deflection deformation of the boom, so that the deflection in the long boom state can be reduced by 20%-30% and the lifting capacity can be improved by more than 200%.



Hoist

- Main hoist: Planetary gear reducer driven by hydraulic motor and special rope groove winch drum, with a built-in brake.
- Wire rope lock: The end of the wire rope is cast and directly installed in the lock sleeve, which improves the reeving speed.
- Specification of wire rope: Φ24-2160, non-rotating wire rope.
- Max. single rope speed (at the 4th layer): approx. 130m/min.



Luffing system

- Double cylinders are adopted, the hydraulic system adopts dual-pump converging open hydraulic circuit, and the combination of electric proportional control, active luffing and passive luffing down can realize fast luffing at large elevation and stable slow luffing at small elevation.
- Luffing angle: 0°~84°.



Slewing

- It is composed of fixed displacement motor and slewing reducer with mature technology and widely used on wheel cranes, at the same time, it adopts external meshing with slewing bearing to realize 360° full-slewing and stepless speed regulation; the slewing hydraulic system adopts a closed system, which can not only avoid the throttling loss of the open system, but also make the system have high efficiency; electric proportional brake pedal is used to realize emergency braking.



Counterweight

- Combined variable counterweights from 0t to 143t can meet the needs of different working conditions, maximize the performance of structural parts, achieve remote removal and installation, and a good inching-movement.

Crane Introduction

Hydraulics

- The open and closed independent hydraulic system of the superstructure has the characteristics of high load sensitivity, heavy load low speed, low load high speed and high action efficiency. The luffing and telescopic system adopts an open system composed of an electro proportional pump and a self-made main valve, which has four pressure levels for selection, and different pressure levels are used for different actions, combined with the displacement of the electric proportional pump, so as to realize energysaving and safe luffing and telescopic actions; the hoist system adopts a closed system to avoid the throttling loss of open system, so that the system has high efficiency and wide speed regulation range; the slewing system is a closed system, which can avoid the throttling loss of open system, so that the system has high efficiency and good inching-movement performance; in addition to the functions of superstructure slewing, boom luffing, extension and retraction, and main and auxiliary hoist lifting, it can also realize the functions of counterweight lifting, operator's cab rotation, and turntable locking.
- The pump, piston motor and balanced valve adopt highquality components with high reliability; the electric proportional variable displacement piston pump can adjust the displacement of the oil pump in real time, realizing high-precision flow control and minimize energy waste; the dual-pump converging/shunting main valve independently developed by SANY has high converging efficiency of single action dual-pump and high shunting controllability of combined action dual-pump.
- The hydraulic system with passive luffing down compensation is adopted, which has good luffing down inching-movement and stability.
- The main boom adopts a single cylinder pin telescopic system.

Control system

- Powered by 24 V DC, it adopts IFM controller, cable wiring, CAN-BUS control network, and combines with conventional electrical to realize the logic control and electrical proportional control functions of the system.
- It has the functions of system real-time monitoring and automatic fault diagnosis.
- Lifting, slewing and luffing are controlled by two auto resettable multidirectional electric proportional joystick; counterweight lifting, operator's cab tilting and turntable locking are all controlled by keys on the control panel.
- The display is connected with the controller by CAN bus, and its main functions include digital adjustment and display of electric proportional control parameters, fault code display of electric proportional system and real-time detection data display of hydraulic system.

Safety equipment

- A method of analytical mechanics is adopted and a load moment indicator calculation system based on the lifting mechanics model is established. Through online empty-load calibration, the lifting accuracy can reach $\pm 3\%$.
- The hydraulic system is equipped with hydraulic balance valve, relief valve, two-way hydraulic lock, etc. to realize the stability and reliability of the hydraulic system.
- The boom and luffing jib hoists are equipped with 3rd wrap indicators to prevent over-hoist-down of the wire rope.
- The boom head and jib head are equipped with A2B switch to prevent the wire rope from over winding.
- The boom head is equipped with an anemometer to detect whether the wind speed exceeds the allowable range.
- Superlift device retracting and releasing rope tension protection, fixed jib installation and lifting protection.

Counterweight Combinations

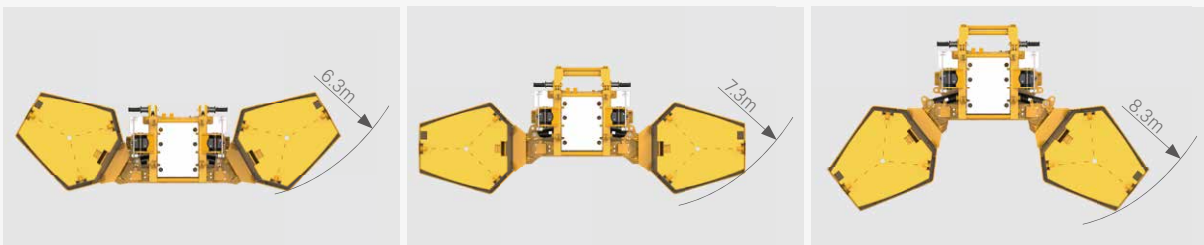
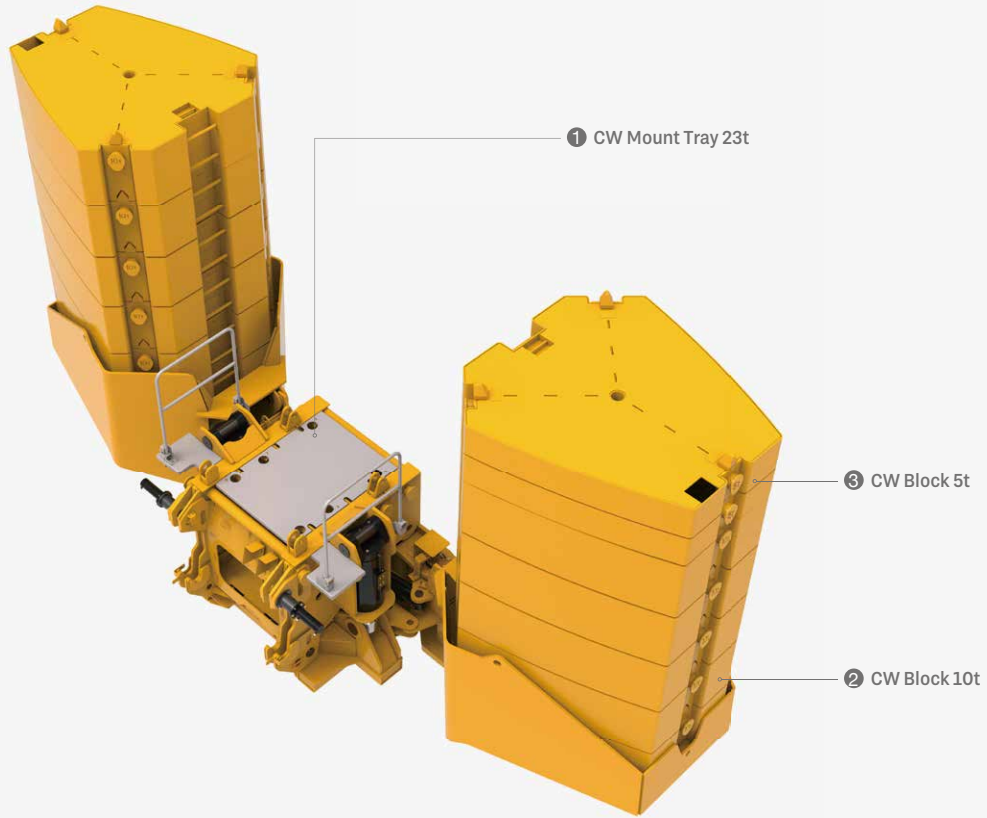

Total weight (t)	Combination
0	0
23t	①
33t	① + 2 × ③
43t	① + 2 × ②
53t	① + 2 × ② + 2 × ③
63t	① + 4 × ②
73t	① + 4 × ② + 2 × ③
83t	① + 6 × ②
93t	① + 6 × ② + 2 × ③
103t	① + 8 × ②
113t	① + 8 × ② + 2 × ③
123t	① + 10 × ②
133t	① + 10 × ② + 2 × ③
143t	① + 11 × ② + 2 × ③

Jib Assembly

Fixed jib assembly (standard)

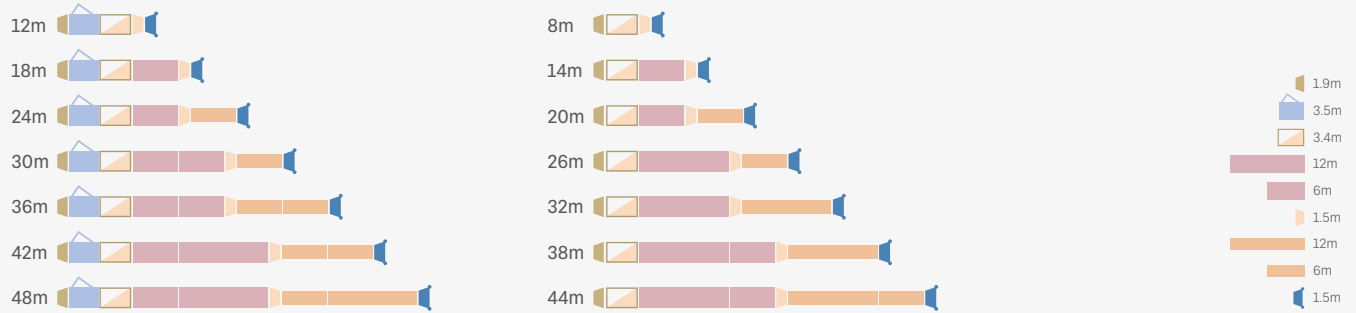

Wind power jib head (optional)

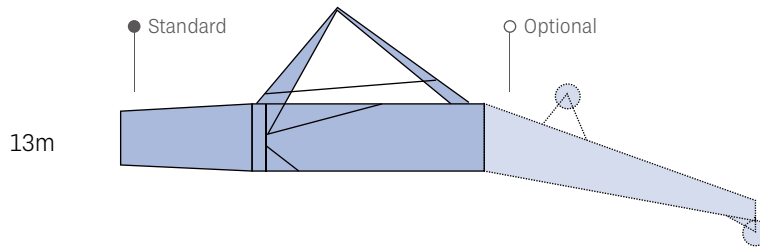

Luffing jib assembly (optional)

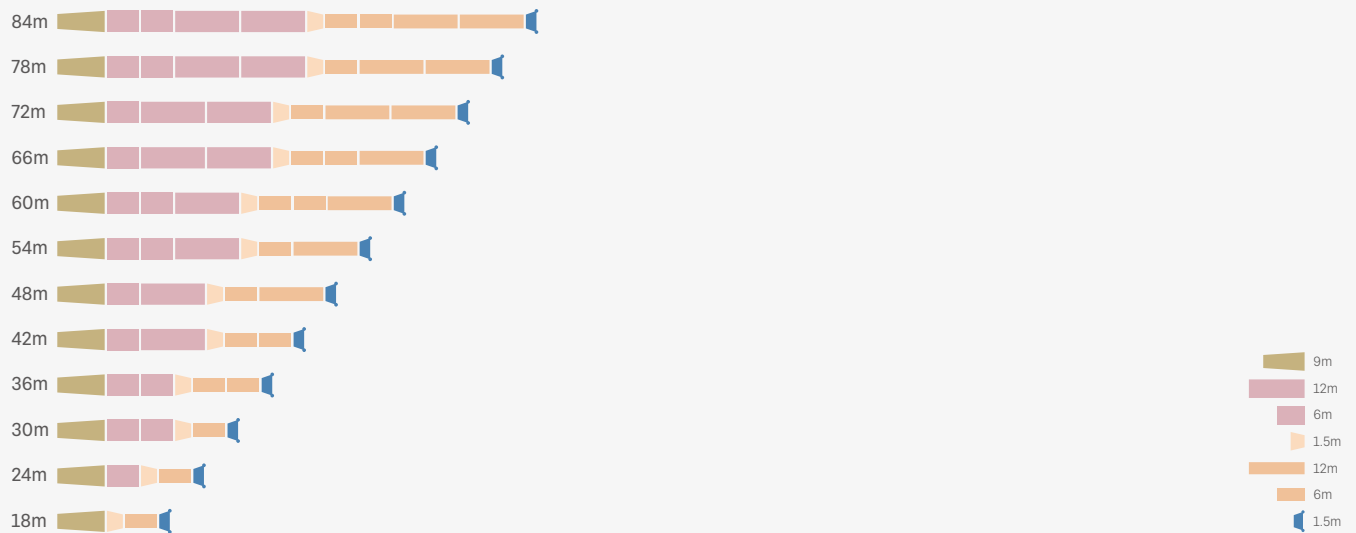

On-Site Heavy-Duty Driving Solutions

Thanks to the heavy-duty axles and 505 tires, SAC5000T7 is able to travel safely and efficiently between jobsites, in three different solutions.

- 1 With all boom sections and outriggers

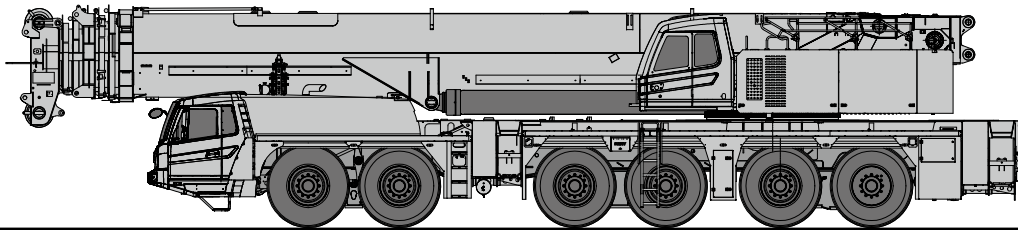

118t

- 2 With all boom sections, outriggers, superlift device, and hook block

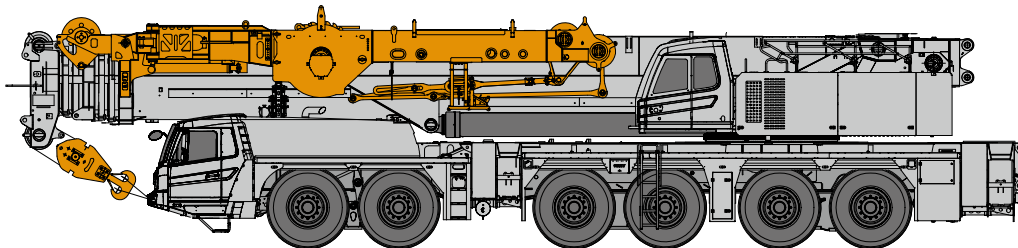

133t

- 3 with all boom sections, outriggers, superlift device, hook block, and outrigger pads

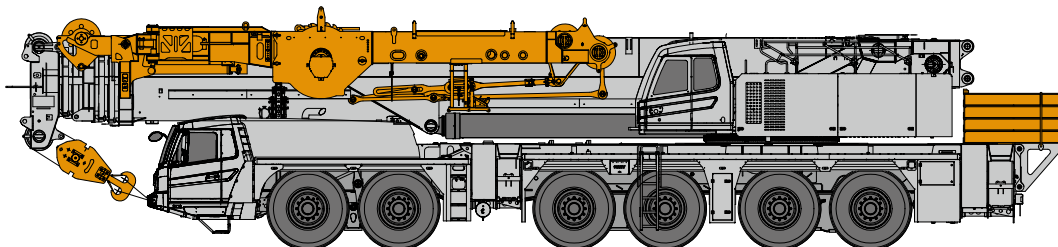

142t

Working Conditions & Code Description

- T** Telescopic boom
- S** Superlift device
- J** Fixed jib
- A** A jib
- L** Luffing jib

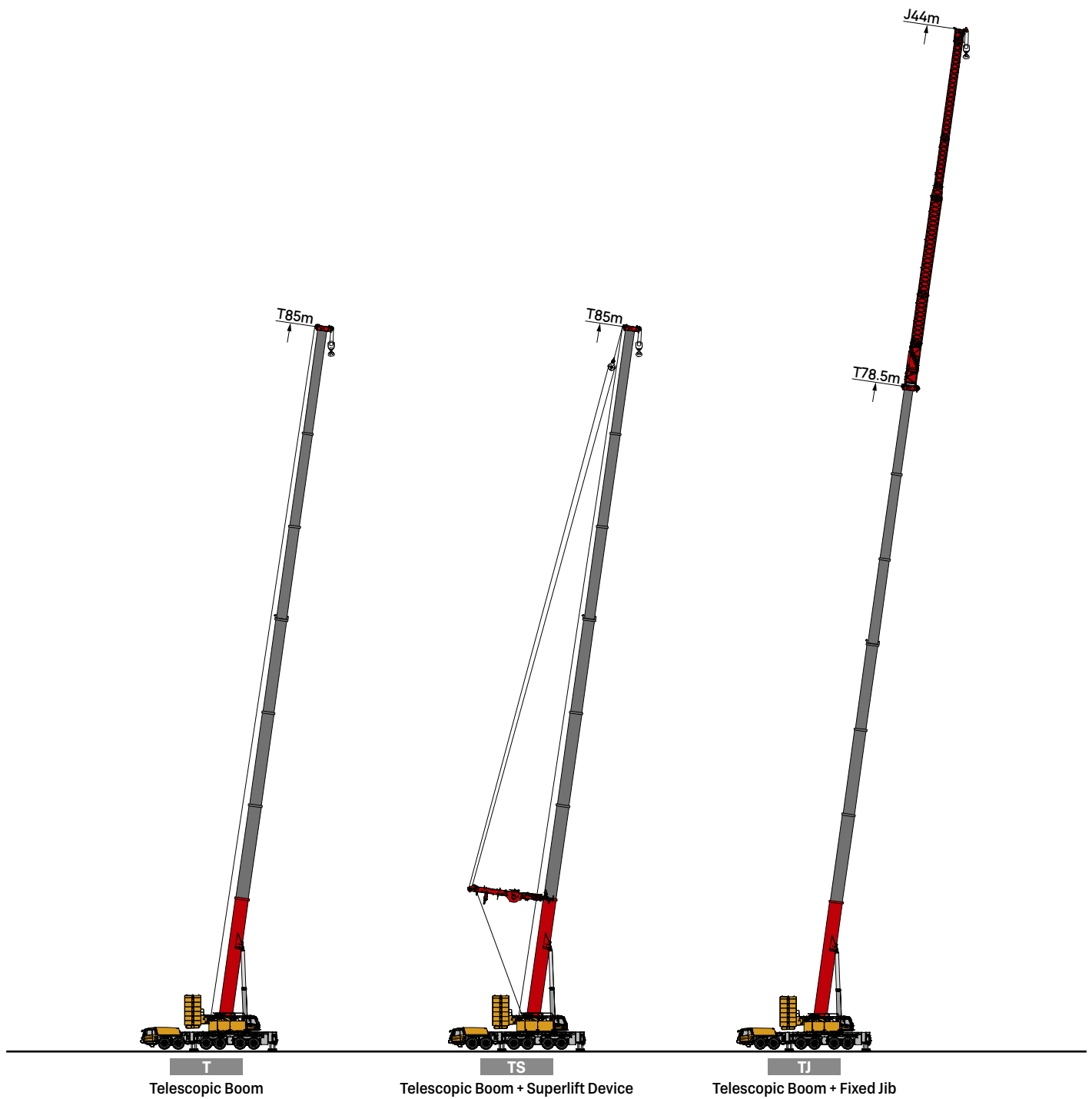

Working Conditions & Code Description



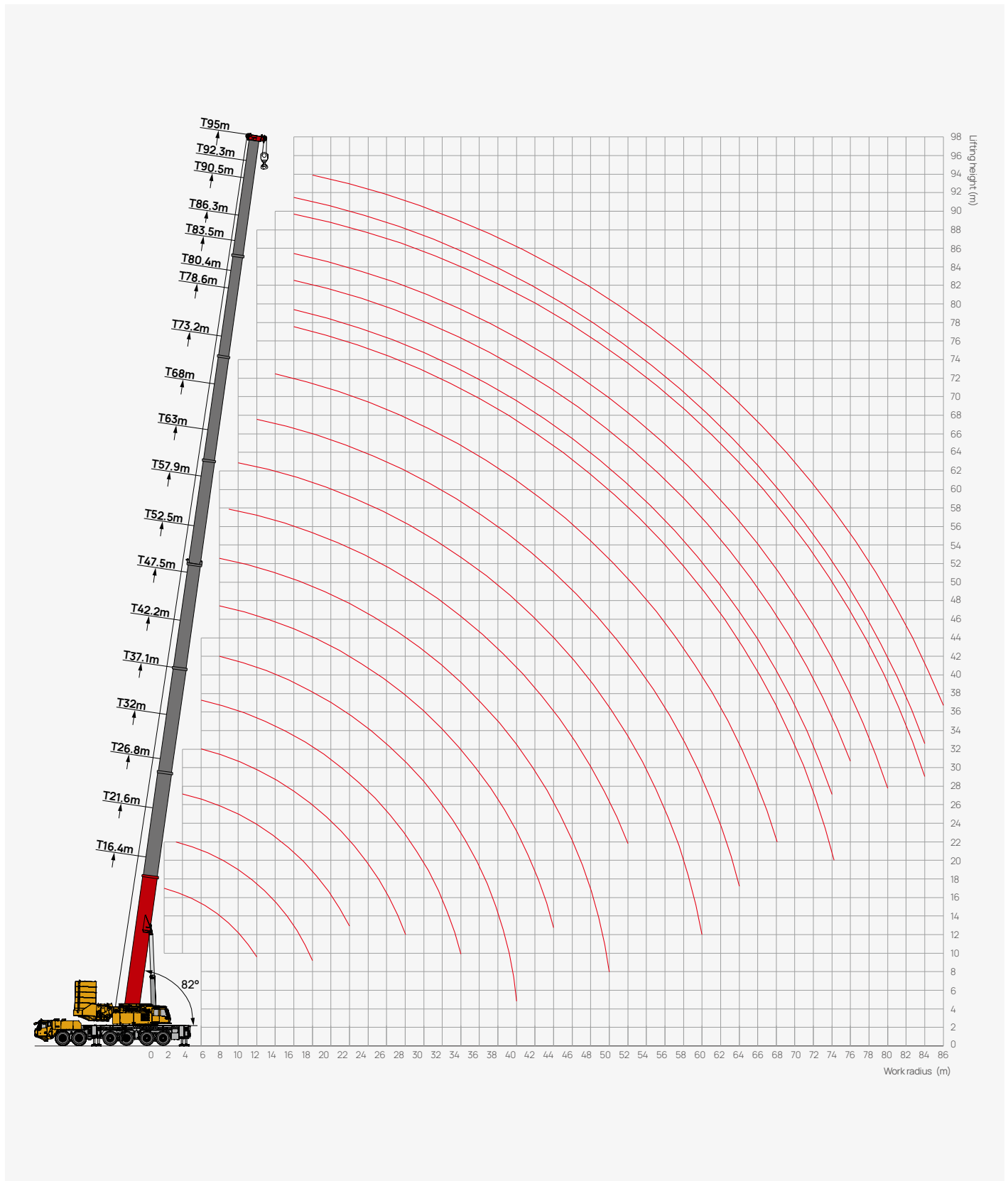

Operating Range - Telescopic Boom (T)

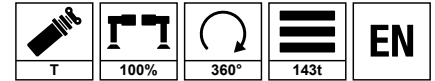

Load Chart - Telescopic Boom (T)



Unit: t



 m	16.4	21.6	26.8	32.0	37.1	42.3	47.5	52.6	57.8	62.9	 m
2.5	600*										2.5
3	225										3
3.5	225	225									3.5
4	225	225									4
4.5	220	225	172								4.5
5	215	215	167	185.3							5
6	210	206	160	181	175						6
7	198	195	151	178	173	165					7
8	180	178	141.5	165	157	160	155				8
9	166.5	162.6	132	155	150	143	147	87.5	105		9
10	153	153	125	150	140	135	128	83	96	82	10
12	125	127.5	110	125	125	122	115	77.3	85	78	12
14		110	98	106	108	106	100	74.1	73.1	68	14
16		88	90	93	95.5	88.5	86.1	70.3	63.8	60.6	16
18		71	81.7	82.3	83	76.6	76.6	67.6	56.9	51.5	18
20			72.5	73.4	74.5	67.8	68.7	63.5	53.3	46.5	20
22			65	65.3	66	60.5	61.2	60.6	49.4	44.8	22
24				56.3	58	53	58	55.9	45.3	42.4	24
26				49.2	51.3	47.5	52.7	51.8	41.6	39.1	26
28				39.4	46.3	43	47.9	47.9	38.4	36.2	28
30					41.8	39	43.5	43.1	35	33.7	30
32					36.2	35	38.2	38.7	32.5	30.3	32
34					22.5	31.1	35.3	34.8	30.4	27.7	34
36						27.8	33.3	32.4	28.3	25.9	36
38						23.9	29.5	31.2	26.5	24.3	38
40						12.2	26	28.5	25	22.4	40
42							23.5	25.8	23	21	42
44							16.7	23.5	21.5	19.2	44
46								21.6	18.2	17.3	46
48								18	16.8	15.5	48
50								10	15.1	14.4	50
52									13.5	12.9	52
54										11.5	54
56										10.1	56
58										8.9	58
60										4	60
62											62
64											64
66											66
68											68
70											70
72											72
74											74
76											76
78											78
80											80
82											82
84											84

Remark: * Requires lifting capacity level.

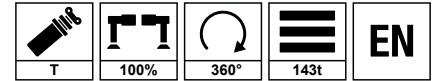
Load Chart - Telescopic Boom (T)



Unit: t

 m	68.1	73.3	78.6	80.4	83.5	86.3	88.7	90.5	92.3	95.0	 m
2.5											2.5
3											3
3.5											3.5
4											4
4.5											4.5
5											5
6											6
7											7
8											8
9											9
10											10
12	65										12
14	60.1	51									14
16	53	48.6	45	36.7	27.6	30.5	26.3	25.3	24.2		16
18	46.7	44	37.1	35.7	25.5	29.1	25.7	24.9	23.7	21	18
20	41	39.8	35.5	34.6	24.7	28.5	24.7	24.3	23.3	20.8	20
22	38	35.7	33.7	33	23.9	27.3	24.5	23.8	22.9	20.6	22
24	35.3	34.4	28.3	28.9	23.2	25.9	23.5	22.5	21.6	20.4	24
26	34	33.2	27	26.9	22.2	24.8	23	21.7	20.8	19.6	26
28	31.1	32.1	25.5	25.4	21.3	23.1	22.2	21	20.2	18.7	28
30	30.3	30.1	24.3	24.1	20.3	21.5	20.7	20	19.5	18	30
32	28	27.4	23.4	23.2	19.9	20.5	19.3	19.2	18.8	17.5	32
34	26.8	25.6	22.4	22.3	19.1	19.9	18.2	17.9	17.7	17	34
36	25.2	24.2	21	21.2	18.2	18.7	17.1	16.9	16.6	16.4	36
38	23.6	22.6	19.9	20.2	17.3	18	16.4	16.3	15.7	15.6	38
40	21.9	21.3	18.8	19	16.5	17	15.7	15.6	15	14.8	40
42	20.5	19.7	17.8	18	15.9	16.3	15.1	15	14.4	13.8	42
44	18.9	18.8	16.5	16.7	14.8	15.1	14	13.9	13.6	13.4	44
46	17.2	17.3	15.6	15.8	14.2	14.3	13.5	13.4	13	12.6	46
48	15.5	15.9	14.6	14.7	13.2	13.6	12.8	12.7	12.1	11.7	48
50	13.9	14.4	13.8	13.9	12.7	12.9	12.1	12.2	11.7	11.3	50
52	12.4	12.9	13.1	13	12.2	12.3	11.8	11.6	11.3	11	52
54	11	11.5	11.9	11.6	11.8	11.7	11.4	11.3	10.9	10.6	54
56	9.8	10.3	10.6	10.4	11	11	10.6	10.5	10.4	10	56
58	8.6	9.4	9.5	9.2	10.7	10.3	10.3	10.2	9.8	9.7	58
60	7.5	8.3	8.4	8.2	9.9	9.2	9.6	9.5	9.2	8.9	60
62	6.5	7.2	7.4	7.3	9.4	8.5	9.2	9.1	8.7	8.6	62
64	5	6.2	6.5	6.4	8.7	7.5	8.5	8.2	8.1	8	64
66		5.3	5.6	5.5	8.4	6.6	7.6	7.4	7.4	7.7	66
68		4.4	4.8	4.6	7.9	5.7	6.8	6.5	6.7	7	68
70			4	3.8	7.1	4.9	6.1	5.8	5.9	6.3	70
72			3.2	3	6.2	4.1	5.5	5.2	5.2	5.5	72
74			2.5	2.3	5.5	3.4	4.8	4.4	4.4	4.8	74
76					4.9	2.7	4.1	3.8	3.8	4.1	76
78						2.1	3.4	3.1	3.1	3.5	78
80						1.5	2.8	2.5	2.5	2.9	80
82							2.2	1.9	1.9	2.3	82
84										1.7	84

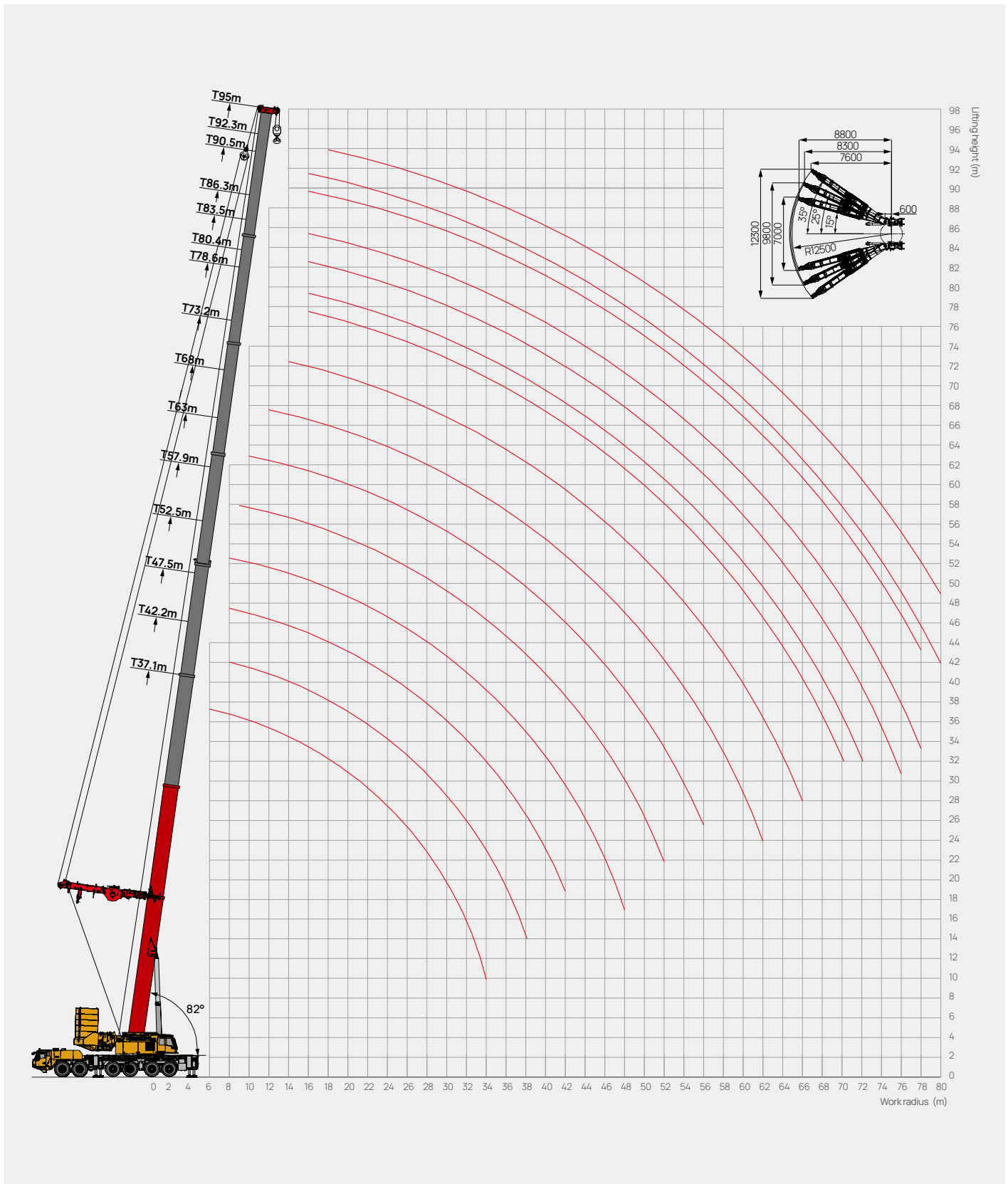

Operating Range - Telescopic Boom + Superlift Device (TS)

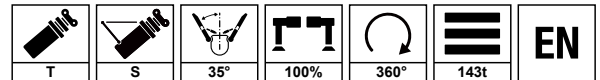

Load Chart - Telescopic Boom + Superlift Device (TS)



Unit: t

 m	37.1	42.3	47.5	52.6	57.8	62.9	68.1	73.3	78.5	81.2	84.5	88.7	91.4	93.2	95.0	 m
5	185															5
6	185	165														6
7	185	165	155													7
8	175	165	155	135												8
9	165	164	150	132												9
10	150	150	145	130	123											10
12	125	125	125	125	115	111	100									12
14	108.2	108	108	105	110	108	98	89								14
16	96	95.2	95	95	92.3	95	95	85	78	74	62	58	55			16
18	82	82.5	82.5	85	82.6	84.5	85	77.8	72.3	66.8	58.5	55.1	52.6	51	45	18
20	72	71.2	78	76	75	75	75	72	67.4	62.7	54.1	51.6	49.3	46.8	42.5	20
22	59.2	62.7	64.6	70	68	68	68.6	66.6	62.3	59.3	51.1	47.9	46.2	43.6	40.7	22
24	52.3	55.7	58.4	59.3	58	61	60.3	60.5	57.8	56	48.7	45.5	42.7	41.8	37.6	24
26	46.5	49.2	53	53.4	52	52	52.3	55	53.6	51	45.4	42.9	40.3	39.5	35	26
28	41.2	42.9	46.2	47.6	46.6	46.8	46.4	47.1	47.9	47.8	42.6	40.8	38.2	36.8	32.1	28
30	35.6	38.6	41.6	40.3	43.2	43.2	42	42.6	42.6	42.4	40.7	37.2	36	34.2	29.9	30
32	28.6	34.9	37.5	37	36.9	39.5	38.6	38.8	39.6	38.6	37.8	36.1	34.1	32	28.6	32
34	18.3	30.6	34	33	33.5	35	35.3	35.3	36.3	36.4	34.9	34.3	30.5	30	26.8	34
36		25.6	31.1	30	30.6	32.1	33.4	32.2	33.2	33.2	33.4	32.5	29.4	27.9	24.5	36
38		19.3	28.2	27.2	28	29	28.6	30	30.1	27.8	31.3	30.8	27.5	26	22.7	38
40			25.5	24.5	25	26.8	26.1	27.2	27.1	25.3	26.6	26.9	25	23.9	21.2	40
42			20.1	22.2	22.9	24.9	23.8	25	24.5	23.1	24	24.4	22.6	21.8	20.3	42
44				20.7	20.9	22.8	21.7	23	22.1	21	22.8	22.2	21	19.9	19.4	44
46				17.2	18.8	21	19.9	20.7	19.9	19.4	21.3	20.2	20	19.3	18.5	46
48				13.5	16.2	18.2	18.1	19	17.9	18.1	19.8	19.1	18.3	18	17.7	48
50					15.3	16.4	16.6	17.4	16.1	16.9	18.2	17.9	17.5	17.1	16.9	50
52					13.2	14.5	15.1	15.9	14.5	15.7	15.4	16.3	16	16.2	16.1	52
54						12.7	13.8	14.6	13	12.8	13.9	14.8	14.5	14.7	15	54
56							11.1	12.5	13.4	11.6	11.4	12.5	13.4	13.2	13.3	56
58								10.9	12.2	10.3	10.1	11.2	12.2	11.9	12.1	58
60								8.8	11.1	9.1	8.9	9.9	11.2	10.7	10.9	60
62								6.2	9.7	7.9	7.7	8.8	10.4	9.6	9.8	62
64									7.8	6.9	6.7	7.8	9.6	8.6	8.7	64
66									5.7	5.9	5.7	6.8	8.1	8	7.8	66
68										5	4.8	5.9	7.1	7	6.9	68
70										4.1	3.9	5	6.3	6.2	6	70
72											3.1	4.2	5.5	5.3	5.2	72
74											2.3	3.4	4.7	4.4	4.5	74
76												2.7	4	3.6	4.1	76
78													3.3	3	3.1	78
80														2.5	2.8	80

Operating Range - Telescopic Boom + Fixed Jib (TJ)

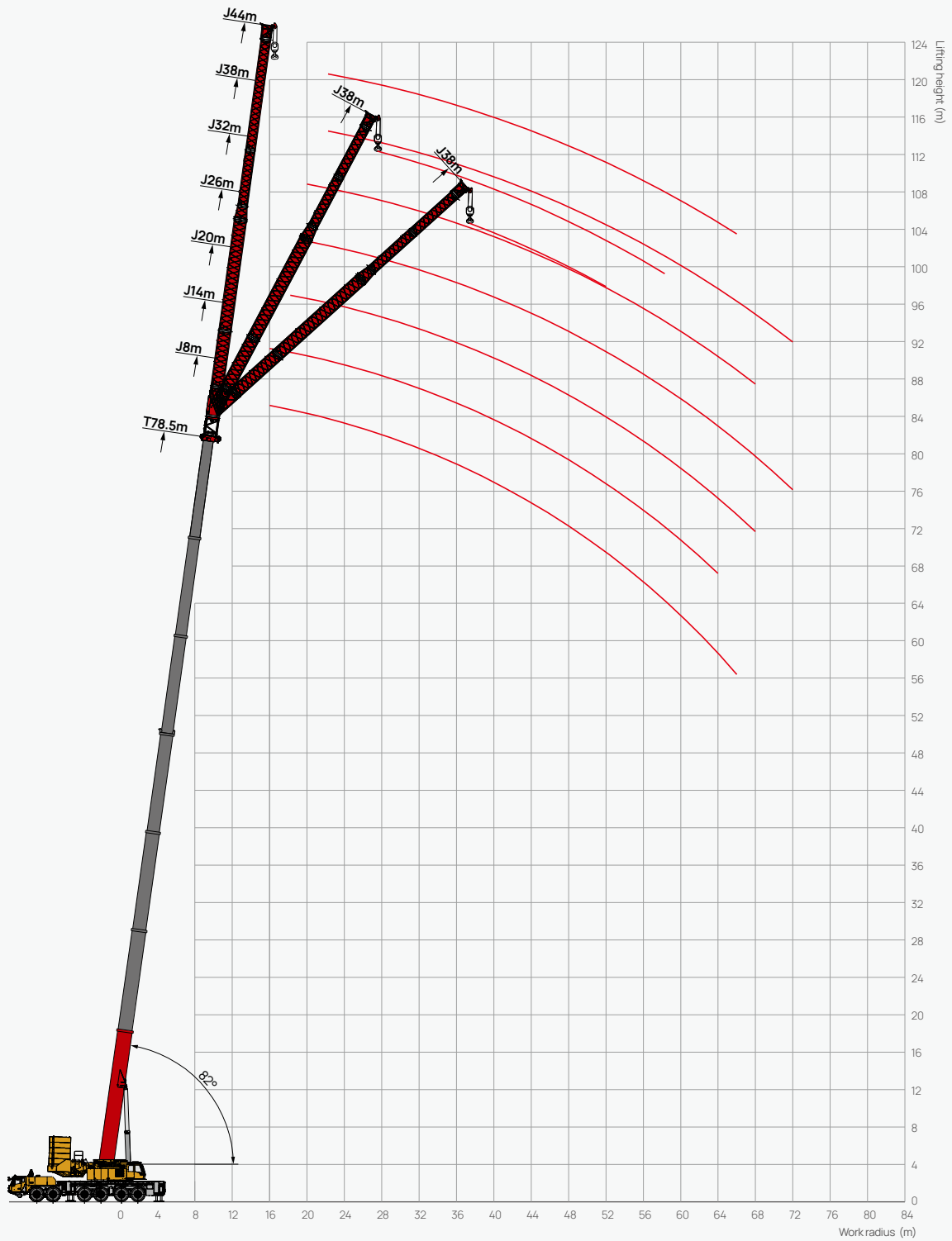

Load Chart - Telescopic Boom + Fixed Jib (TJ)

Unit: t

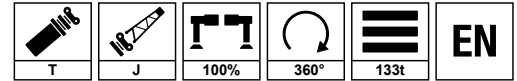

Jib m	62.9m							68.1m							Jib m
	8m	14m	20m	26m	32m	38m	44m	8m	14m	20m	26m	32m	38m	44m	
10															10
12															12
14	23.1	23.6	20.5					18.7	20.0						14
16	21.8	22.4	19.2	15.9	14.2			18.1	18.9	15.6	13.6				16
18	20.7	21.4	17.5	15.1	13.4	11.1		17.4	17.8	14.8	12.8	12.3			18
20	19.3	20.2	16.4	14.3	12.6	10.7	9.5	16.5	16.8	14.0	12.2	11.7	9.7	8.2	20
22	17.9	19.1	15.2	13.6	11.7	10.3	8.9	15.6	16.0	13.2	11.5	11.2	9.3	7.6	22
24	16.8	17.9	14.6	12.8	11.0	9.8	8.2	14.7	15.1	12.4	10.9	10.6	8.9	7.0	24
26	15.6	16.6	13.9	12.0	10.4	9.2	7.5	13.9	14.2	11.7	10.1	9.9	8.5	6.6	26
28	14.5	15.5	13.2	11.2	9.7	8.7	6.9	13.0	13.4	11.2	9.5	9.2	8.0	6.2	28
30	13.4	14.3	12.4	10.4	9.2	8.4	6.3	12.1	12.5	10.8	8.8	8.5	7.6	5.7	30
32	12.6	13.3	11.8	9.7	8.8	7.9	5.8	11.3	11.7	10.2	8.3	7.9	7.3	5.3	32
34	11.8	12.3	11.1	9.4	8.2	7.7	5.4	10.6	10.9	9.6	7.8	7.4	6.9	4.9	34
36	10.9	11.4	10.4	8.9	7.6	7.4	5.1	9.9	10.2	9.2	7.4	6.8	6.7	4.7	36
38	10.1	10.6	9.9	8.4	7.0	7.0	5.0	9.2	9.4	8.7	7.1	6.3	6.5	4.6	38
40	9.4	9.8	9.2	8.1	6.6	6.7	4.9	8.6	8.7	8.0	6.8	5.9	6.1	4.4	40
42	8.7	9.0	8.6	7.6	6.3	6.4	4.6	8.0	8.2	7.6	6.5	5.5	5.7	4.3	42
44	8.0	8.3	8.0	7.2	5.8	6.1	4.4	7.4	7.5	7.0	6.2	5.1	5.4	4.2	44
46	7.4	7.6	7.5	6.7	5.5	5.9	4.3	6.8	6.9	6.5	6.0	4.8	5.2	4.1	46
48	6.7	6.9	7.0	6.4	5.2	5.5	4.1	6.3	6.2	6.1	5.6	4.5	4.9	3.7	48
50	6.2	6.3	6.5	6.0	4.9	5.2	3.9	5.8	5.8	5.6	5.3	4.3	4.6	3.6	50
52	5.6	5.8	5.9	5.6	4.7	4.8	3.7	5.3	5.2	5.1	5.0	4.1	4.3	3.4	52
54	5.0	5.2	5.6	5.3	4.5	4.6	3.5	4.8	4.7	4.8	4.7	3.9	4.0	3.3	54
56	4.6	4.6	5.1	4.9	4.1	4.4	3.3	4.3	4.4	4.3	4.4	3.5	3.8	3.1	56
58	4.2	4.1	4.6	4.6	3.9	4.0	3.1	3.9	3.9	4.0	4.1	3.3	3.5	2.9	58
60	3.8	3.6	4.2	4.3	3.5	3.6	2.9	3.6	3.5	3.6	3.8	3.0	3.2	2.7	60
62	3.4	3.2	3.8	3.9	3.2	3.4	2.7	3.3	3.1	3.1	3.5	2.6	2.9	2.5	62
64	3.2	2.8	3.3	3.5	2.9	3.1	2.5	2.9	2.7	2.9	3.2	2.5	2.6	2.3	64
66		2.5	3	3.1	2.6	2.8	2.3	2.3	2.4	2.4	2.9	2.3	2.4	2.1	66
68		2.2	2.6	2.8	2.1	1.8	2.1		2.1	2.2	2.6	2	2.1	1.8	68
70			2.3	2.4	1.9	1.7	1.8			1.9	2.3	1.7	1.8	1.5	70
72			1.8		1.6		1.8			1.6	2				72
74							1.6								74

Load Chart - Telescopic Boom + Fixed Jib (TJ)

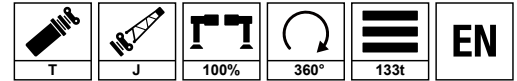

Unit: t

Jib m	73.3m							78.5m							Jib m
	8m	14m	20m	26m	32m	38m	44m	8m	14m	20m	26m	32m	38m	44m	
10															10
12															12
14	15.9														14
16	15.4	16.4	13.3					13.1	13.5						16
18	14.8	15.3	12.5	11.0	10.1			12.7	12.6	10.3					18
20	14.0	14.4	11.7	10.3	9.7	8.3		12.3	11.9	9.7	8.0	7.0			20
22	13.3	13.5	11.0	9.6	9.3	8.0	6.7	11.6	11.2	9.1	7.5	6.7	6.3	5.2	22
24	12.5	12.8	10.4	8.9	8.8	7.7	6.2	11.0	10.6	8.5	7.0	6.4	6.1	4.8	24
26	11.8	12.1	10.1	8.3	8.2	7.4	5.7	10.3	10.1	8.1	6.5	6.1	5.9	4.4	26
28	11.1	11.4	9.6	7.8	7.7	6.9	5.4	9.7	9.5	7.8	6.1	5.7	5.6	4.1	28
30	10.3	10.7	9.2	7.4	7.1	6.6	5.0	9.1	9.0	7.5	5.8	5.4	5.3	3.9	30
32	9.6	10.1	8.8	6.9	6.6	6.3	4.6	8.4	8.4	7.2	5.5	5.0	5.0	3.5	32
34	9.0	9.4	8.3	6.6	6.2	6.0	4.3	7.9	7.9	6.9	5.2	4.7	4.9	3.3	34
36	8.4	8.8	7.9	6.4	5.7	5.8	4.0	7.4	7.5	6.5	5.0	4.4	4.6	3.1	36
38	7.9	8.2	7.5	6.1	5.3	5.6	3.8	6.9	7.0	6.3	4.8	4.1	4.5	2.9	38
40	7.3	7.7	6.9	5.8	5.0	5.3	3.7	6.4	6.5	5.9	4.6	3.8	4.3	2.9	40
42	6.8	7.2	6.6	5.6	4.7	4.9	3.6	6.0	6.2	5.5	4.5	3.6	4.1	2.8	42
44	6.3	6.7	6.1	5.4	4.4	4.7	3.5	5.5	5.8	5.3	4.3	3.4	3.8	2.7	44
46	5.8	6.2	5.7	5.1	4.1	4.5	3.4	5.1	5.4	4.9	4.1	3.2	3.6	2.6	46
48	5.4	5.7	5.3	4.9	3.9	4.3	3.3	4.7	5.0	4.6	4.0	3.0	3.5	2.6	48
50	4.9	5.4	4.9	4.6	3.8	4.0	3.0	4.3	4.7	4.4	3.7	2.8	3.3	2.3	50
52	4.5	4.9	4.5	4.4	3.6	3.8	2.9	3.9	4.3	4.0	3.5	2.7	3.1	2.2	52
54	4.1	4.5	4.2	4.2	3.4	3.5	2.8	3.6	4.0	3.7	3.4	2.6	2.9	2.2	54
56	3.7	4.2	3.8	3.9	3.1	3.3	2.7	3.3	3.8	3.5	3.2	2.5	2.7	2.1	56
58	3.3	3.8	3.6	3.7	2.9	3.1	2.5	2.9	3.5	3.2	3.0	2.3	2.6	2.0	58
60	3.0	3.4	3.2	3.6	2.7	2.8	2.3	2.6	3.1	3.1	2.8	2.2	2.4	1.8	60
62	2.8	3.0	2.8	3.3	2.2	2.6	2.1	2.4	2.8	2.8	2.6	2.0	2.2	1.7	62
64	2.5	2.6	2.6	3.1	2.1	2.3	2	2.1	2.5	2.5	2.4	1.7	2	1.6	64
66	2.1		2.4	2.8	1.9	2.1	1.8	1.9	1.9	2.3	2.2	1.6	1.8		66
68	1.6			2.4	1.7	1.9				2.1	2	1.5	1.7		68
70				2.1	1.5	1.6						1.8	1.5		70
72				1.8								1.6			72
74															74

Operating Range - Telescopic Boom + Fixed Jib + Superlift Device (TSJ)

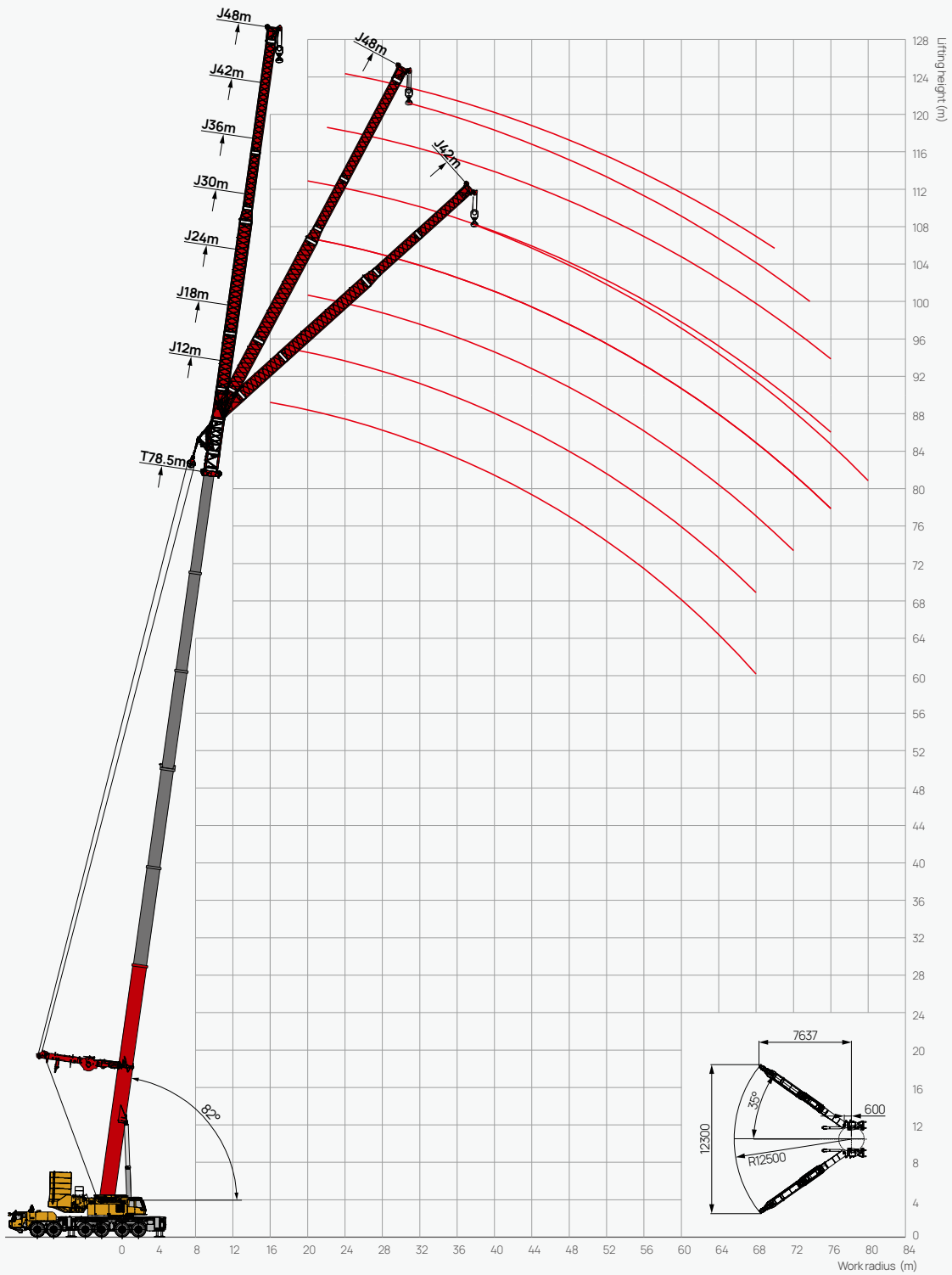

Load Chart - Telescopic Boom + Fixed Jib + Superlift Device (TSJ)

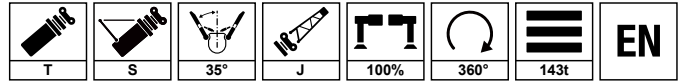

Unit: t

Lift Height m	62.9m							68.1m							Lift Height m
	12m	18m	24m	30m	36m	42m	48m	12m	18m	24m	30m	36m	42m	48m	
12	61							54							12
14	55	48	45					50							14
16	50.1	43.3	41.4	32.5				45.4	41.0	36.3	31.0				16
18	46.6	39.4	37.6	31.0	24.4	20.2	17.9	42.0	37.4	33.4	29.2	23.5			18
20	43.2	35.9	34.7	29.2	23.1	19.2	17.0	38.6	34.2	30.9	26.8	22.5	18.4	14.8	20
22	39.9	33.9	29.5	27.0	22.1	18.2	15.9	36.2	31.7	27.5	25.0	21.5	17.7	14.2	22
24	37.3	32.4	27.3	25.0	21.0	17.2	14.9	34.3	30.6	25.5	23.1	20.6	16.9	13.7	24
26	34.8	31.2	25.4	23.3	19.9	16.4	14.0	31.9	29.4	23.7	21.6	19.7	16.2	13.1	26
28	32.5	29.3	23.4	21.7	19.0	15.6	13.3	29.3	28.2	21.2	20.1	18.4	15.4	12.5	28
30	29.5	25.9	21.9	20.2	18.1	14.9	12.7	26.8	26.5	19.8	18.7	17.1	14.7	12.0	30
32	26.6	23.0	20.5	18.7	16.9	14.2	11.9	23.9	23.5	18.4	17.4	16.1	14.0	11.6	32
34	24.2	20.5	18.9	17.4	15.8	13.6	11.2	21.2	21.0	17.3	16.2	15.0	13.5	10.9	34
36	22.6	18.3	17.7	16.3	14.8	13.0	10.8	19.6	18.9	16.5	15.2	13.9	13.0	10.6	36
38	20.1	17.0	16.7	15.2	13.8	12.4	10.4	18.0	16.9	15.6	14.3	13.2	12.3	10.0	38
40	18.0	16.3	15.9	14.2	13.0	12.0	10.0	16.7	15.8	14.8	13.4	12.3	11.5	9.4	40
42	16.6	15.5	15.1	13.3	12.1	11.5	9.5	15.6	15.2	14.2	12.4	11.5	10.8	9.0	42
44	15.2	14.7	14.3	12.5	11.2	10.7	9.1	14.5	14.3	13.5	11.6	10.7	10.1	8.7	44
46	14.2	13.9	13.5	11.6	10.6	10.0	8.8	13.6	13.7	12.5	10.9	10.0	9.3	8.3	46
48	13.3	13.4	12.5	10.9	9.9	9.3	8.4	12.9	13.1	11.6	10.4	9.3	8.7	7.7	48
50	12.0	12.4	11.6	10.3	9.1	8.7	8.1	12.0	12.3	10.8	9.9	8.7	8.1	6.9	50
52	10.6	11.4	10.7	9.8	8.6	8.0	7.5	10.8	11.4	10.3	9.4	8.0	7.6	6.4	52
54	8.5	9.8	9.9	9.2	8.1	7.5	7.0	9.2	9.7	9.9	8.9	7.5	7.1	5.4	54
56	7.2	8.5	9.4	8.6	7.6	7.1	6.5	7.4	8.7	9.4	8.4	7.3	6.6	4.9	56
58	6.2	7.5	8.8	8.0	7.1	6.5	6.0	6.1	7.7	8.7	7.8	7.2	6.1	4.7	58
60	4.9	6.5	7.9	7.4	6.7	6.2	5.6	4.9	6.6	8.0	6.9	6.9	5.7	4.6	60
62	3.8	5.3	6.9	7.0	6.5	5.8	5.2	3.7	5.5	7.1	6.4	6.5	5.4	4.4	62
64	2.7	4.2	5.9	6.2	6.1	5.4	4.8	2.7	4.3	5.9	6.0	6.0	4.9	4.3	64
66		3.2	4.7	5.4	5.7	5.0	4.5	1.7	3.2	4.8	5.5	5.7	4.8	4.2	66
68		2.2	3.7	4.9	5.3	4.6	4.3		2.3	3.8	4.9	5.3	4.5	4.1	68
70			2.7	4.2	5	4.3	4			2.9	4.2	5	4.2	3.8	70
72			1.8	3.3	3.9	4	3.7			2	3.4	4.5	3.9	3.5	72
74				2.4	3.3	3.6	3.4				2.5	3.5	3.4	3.2	74
76					2.9	3.3	3.1					2.7	3.2		76
78						2.9	2.5						2.8		78
80							2								80

Load Chart - Telescopic Boom + Fixed Jib + Superlift Device (TSJ)

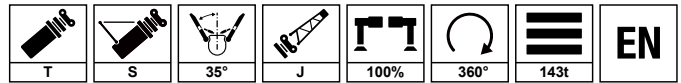

Unit: t

Lift Height m	73.3m							78.5m							Lift Height m
	12m	18m	24m	30m	36m	42m	48m	12m	18m	24m	30m	36m	42m	48m	
12															12
14	43														14
16	41.2	38.0						37.0							16
18	38.2	34.5	30.6	27.0				34.8	31.7						18
20	35.2	32.3	28.3	25.0	20.6	16.8		32.1	29.5	26.1	22.4	18.5			20
22	32.7	29.2	26.1	23.9	19.8	16.1	12.1	30.2	27.6	24.9	21.6	18.0	14.7	11.0	22
24	30.7	27.6	24.4	22.2	19.2	15.4	11.7	28.5	25.8	24.1	20.6	17.6	14.0	10.6	24
26	29.3	26.6	22.4	20.5	18.3	14.7	11.2	26.7	24.2	22.1	19.0	17.0	13.4	10.2	26
28	27.3	25.5	20.0	19.0	17.5	14.0	10.7	25.4	22.9	19.4	17.5	16.2	12.7	9.7	28
30	25.1	24.4	18.8	17.6	16.3	13.3	10.2	23.6	21.4	17.8	16.2	15.4	12.1	9.3	30
32	22.9	22.8	17.5	16.3	15.1	12.7	9.9	21.6	20.1	16.3	15.0	14.3	11.5	9.0	32
34	20.7	20.5	16.3	15.1	14.1	12.2	9.4	19.6	18.6	15.0	13.8	13.2	11.1	8.5	34
36	18.1	18.2	15.2	14.0	13.1	11.7	9.0	17.9	17.0	13.9	12.7	12.3	10.6	8.3	36
38	16.8	16.3	14.4	13.4	12.5	11.1	8.5	15.1	15.6	12.8	12.0	11.7	10.1	7.8	38
40	15.7	14.9	13.7	12.6	11.7	10.3	8.0	14.0	14.0	12.1	11.5	11.0	9.3	7.4	40
42	14.5	13.8	13.0	11.8	10.9	9.7	7.7	13.9	12.9	11.4	10.9	10.3	8.8	7.1	42
44	13.4	13.0	12.2	10.9	10.1	9.0	7.4	12.9	11.6	11.0	10.1	9.6	8.1	6.8	44
46	12.4	12.3	11.6	10.1	9.4	8.3	7.0	11.9	10.9	10.2	9.4	8.8	7.5	6.5	46
48	11.6	11.7	10.8	9.7	9.1	7.7	6.6	10.9	10.3	9.7	9.0	8.5	6.9	6.1	48
50	10.9	11.0	10.0	9.0	8.4	7.2	5.8	10.1	9.8	9.4	8.3	7.8	6.4	5.4	50
52	10.5	10.3	9.2	8.5	7.8	6.8	5.4	9.4	9.1	8.8	8.0	7.6	6.0	5.0	52
54	9.5	9.5	8.8	8.0	7.2	6.3	4.5	8.8	8.5	8.3	7.4	7.0	5.5	4.2	54
56	8.1	8.5	8.4	7.6	6.6	5.9	4.4	8.7	7.5	7.7	6.9	6.5	5.3	3.9	56
58	6.7	7.5	7.9	7.2	6.4	5.4	4.2	7.4	6.5	7.1	6.4	6.0	4.9	3.7	58
60	5.1	6.6	7.5	6.6	6.4	5.0	4.1	6.1	5.7	6.7	6.0	5.7	4.5	3.6	60
62	4.1	5.7	7.0	6.1	6.3	4.9	3.9	4.5	5.0	6.2	5.5	5.5	4.2	3.5	62
64	3.0	4.6	6.6	5.4	6.1	4.8	3.8	3.5	4.5	6.0	5.0	5.5	4.1	3.4	64
66	2.1	3.5	5.0	5.0	5.6	4.7	3.8	2.7	4.0	5.7	4.6	5.4	4.0	3.3	66
68		2.6	3.9	4.8	5.1	4.4	3.7	1.7	2.8	4.3	4.4	5.1	3.7	3.2	68
70			3	4.4	5	4.1	3.4			3.4	4	4.9	3.4	3	70
72			2.1	3.3	4.6	3.7	3.1			2.5	3.7	4.4	3.1	2.8	72
74				2.6	4.3	3.3	2.9			1.7	2.6	4	2.7	2.5	74
76				1.7	3.8	3					2.1	3.8	2.4		76
78					2	2.7						3.4	2.1		78
80						2.5							1.8		80

Operating Range - Telescopic Boom + Superlift Device + Wind Power Jib (TSA)

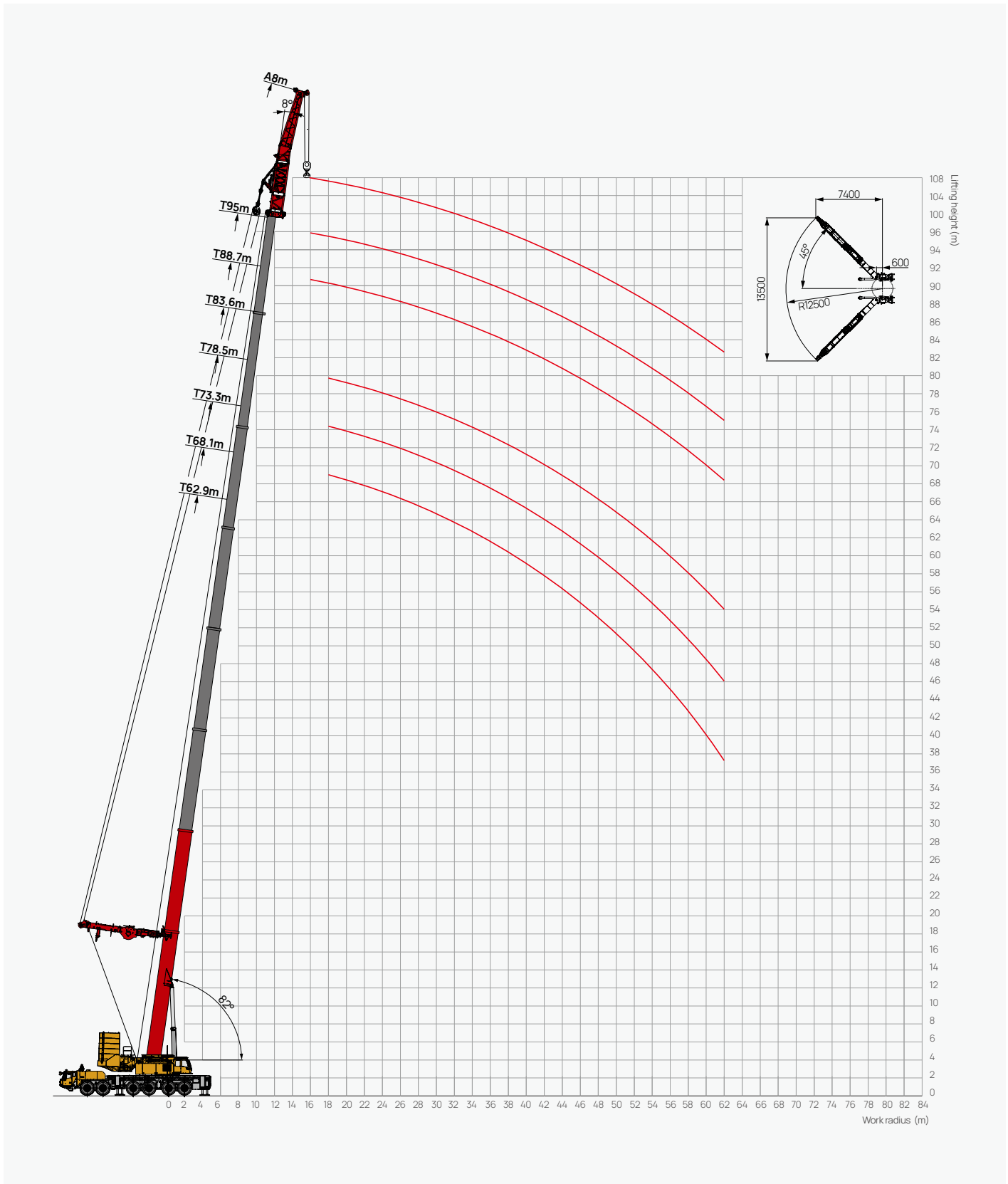

Load Chart - Telescopic Boom + Superlift Device + Wind Power Jib (TSA)

* Rear position 2
配置全后移

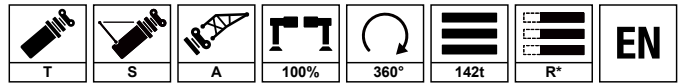

Unit: t

 m	62.9	68.1	73.3	78.5	83.6	88.7	90.5	93.2	95	 m
10										10
12										12
14	78									14
16	75	72	65	58.6						16
18	66	63.5	56.2	53.6	48	38	36	32		18
20	61.8	58.6	51.1	48.6	43.2	35.5	33.4	30.6	30	20
22	56.5	52.9	45.3	43.6	38.5	33.3	31	29.5	29.3	22
24	50.2	49	43	40.1	35.4	31.4	30.3	28.6	27.8	24
26	44.1	40.5	40.2	36.6	32	29.5	29.4	27.2	26.5	26
28	41.3	37.7	37	34.5	30.8	28.5	27.8	26.1	25.1	28
30	38.5	33.5	31.3	30.7	28.6	26.6	26	24.4	23.8	30
32	35.7	30.3	29.5	28.6	26.5	24.1	23.8	23	22.6	32
34	32.9	28	27	25.1	23	21	20.4	20.2	19.2	34
36	30.1	25.1	24.2	22.5	20.2	19.5	19	18.8	18.5	36
38	27.3	23.5	23	21.1	18.6	17.3	17.2	16.5	16	38
40	24.5	22	20.5	18.2	15.3	14.4	14.1	13.9	13.3	40
42	21.7	20.5	19.2	16.6	14.1	13.2	13	12.8	12.2	42
44	18.9	17	16.5	13.1	12.5	12.2	12.1	11.7	11.5	44
46	16.1	15.5	14	11	9.8	9.5	9	9	8.8	46
48	13.3	12.8	11.1	9.5	9	8.3	8.1	7.9	7.6	48
50	11.4	11.2	10.7	8.8	8.1	7.5	7	6.8	6.5	50
52	10.6	10.5	9.5	8.2	7.6	6.6	6.2	6	5.8	52
54	9.5	9.2	8.8	7.6	7	6.3	5.8	5.7	5.3	54
56	9	8.9	7.9	7	6.2	5.8	5.2	5	4.5	56
58	8	7.8	7.2	6.9	5.3	4.7	4.4	4.1	3.9	58
60	6.9	6.7	6.4	5.8	4.6	3.5	3.3	3	2.7	60
62	5.9	5.8	5.5	5.3	4	2.8	2.3	2.2	2	62
 m	7	6	6	5	4	4	4	4	4	 m

Operating Range - Telescopic Boom + Luffing Jib + Superlift Device (TSL)

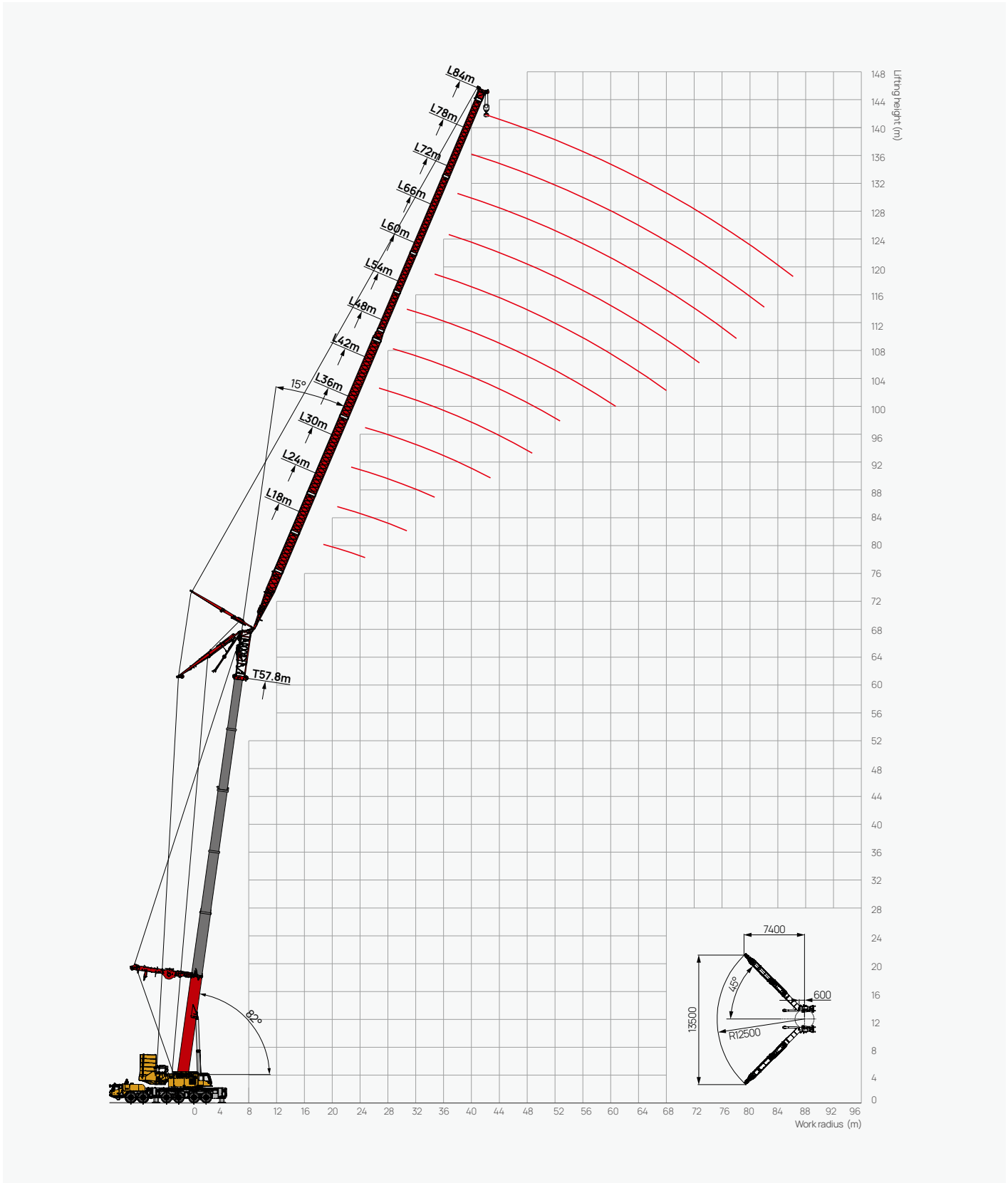

Load Chart - Telescopic Boom + Luffing Jib + Superlift Device (TSL)

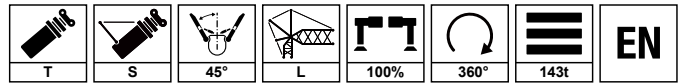

Unit: t

Lift m	42.3m												Lift m
	18m	24m	30m	36m	42m	48m	54m	60m	66m	72m	78m	84m	
14	61												14
16	56.7	51.2											16
18	54.1	50.4	45.2										18
20	53.2	50.0	43.4	36.8									20
22	51.2	49.3	42.5	36.5	30.7								22
24	44.6	48.6	41.8	35.8	30.7	28.1							24
26	42.5	45.7	41.0	34.4	30.7	27.1	24.4						26
28		42.0	40.3	33.8	30.3	26.0	23.3	18.9					28
30		37.7	39.0	33.1	29.6	25.0	22.4	18.2	16.1				30
32		34.8	36.0	32.8	28.4	24.6	21.5	17.4	15.6	13.7			32
34		32.2	34.0	31.4	27.3	24.3	20.5	16.8	14.9	13.2	12.8		34
36		24.4	29.6	30.0	26.0	23.9	19.7	16.2	14.4	12.7	12.4	9.0	36
38		22.4	27.6	28.7	24.3	23.6	19.5	15.6	13.9	12.3	12.1	9.0	38
40			25.9	27.2	23.0	23.2	19.3	15.0	13.4	11.9	11.7	9.0	40
42			19.4	24.0	21.8	22.9	19.0	14.5	13.0	11.5	11.3	9.0	42
44			18.3	22.6	20.7	22.3	18.7	14.0	12.6	11.1	10.9	9.0	44
46				21.3	20.0	21.1	18.6	13.8	12.2	10.7	10.7	9.0	46
48				15.8	19.1	20.1	18.4	13.7	11.8	10.3	10.5	9.0	48
50				14.9	18.7	19.0	18.3	13.5	11.5	10.0	10.4	9.0	50
52					17.8	17.5	17.6	13.4	11.2	9.6	10.0	9.0	52
54					13.0	16.6	16.5	13.2	11.0	9.4	10.0	9.0	54
56					12.3	12.0	15.6	13.1	10.8	9.2	9.7	9.0	56
58						11.4	14.8	13.0	10.7	8.9	9.4	9.0	58
60						10.8	13.5	12.7	10.5	8.7	9.2	8.7	60
62							13.0	12.5	10.4	8.5	8.8	8.4	62
64							12.3	12.2	10.2	8.4	8.8	8.2	64
66							8.8	11.6	9.8	8.2	8.4	7.9	66
68							8.4	11.1	9.2	8.1	8.1	7.6	68
70								7.4	8.4	7.9	7.4	7.5	70
72								7.1	7.3	7.8	7	7.2	72
74								6.8	6.8	7.6	6.6	6.9	74
76									4.4	7.2	6	6.8	76
78									4.1	6.5	6	6.5	78
80									3.8	6	5.3	6.4	80
82										4.5	5.3	6.1	82
84										4.3	5.2	5.8	84
86										4.2	3.7	3.7	86
88											3.4	3.5	88
90												3.4	90
92												1.9	92
94												1.8	94

Load Chart - Telescopic Boom + Luffing Jib + Superlift Device (TSL)

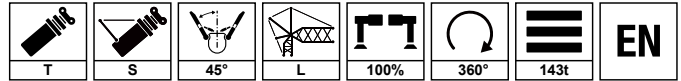

Unit: t

Jib Height (m)	47.5m												Jib Height (m)
	18m	24m	30m	36m	42m	48m	54m	60m	66m	72m	78m	84m	
14	58												14
16	54.4	44.5											16
18	51.9	43.9	38.5										18
20	51.0	43.5	37.0	34.1									20
22	49.1	42.9	36.2	34.1	27.5								22
24	44.8	42.2	35.6	34.1	27.5	25.2							24
26	43.5	43.0	35.0	33.0	27.5	24.3	23.2						26
28	40.6	40.2	36.3	31.9	26.3	23.3	22.5	18.1					28
30		36.8	35.0	30.7	25.8	23.1	21.4	17.5	15.6				30
32		34.0	33.4	30.0	25.1	22.6	20.6	16.8	15.0	11.3			32
34		31.5	31.0	28.6	24.7	21.9	19.8	16.2	14.5	11.1	10.2		34
36		29.3	28.8	27.4	24.0	21.3	18.5	15.7	14.0	10.8	9.9	8.8	36
38		21.7	26.9	26.1	23.0	20.9	17.9	15.1	13.6	10.4	9.6	8.8	38
40		19.9	25.2	24.6	21.8	20.6	17.8	14.6	13.1	10.0	9.3	8.8	40
42			18.6	24.2	20.7	20.1	17.4	14.2	12.7	9.7	9.0	8.8	42
44			17.4	21.2	19.7	19.7	16.7	13.8	12.4	9.4	8.7	8.8	44
46			16.4	19.6	18.9	19.2	16.5	13.7	12.0	9.0	8.6	8.8	46
48				19.1	18.4	18.5	16.3	13.5	11.6	8.6	8.4	8.8	48
50				14.1	15.4	17.4	15.9	13.4	11.3	8.4	8.3	8.8	50
52				13.4	15.1	16.1	15.1	13.2	11.0	8.2	8.1	8.8	52
54					12.2	15.4	14.4	13.1	10.8	8.2	8.0	8.8	54
56					11.6	14.7	13.6	13.0	10.5	8.2	7.8	8.6	56
58					11.0	10.6	12.9	12.5	10.2	8.1	7.6	8.2	58
60						10.2	11.5	11.8	9.9	8.0	7.4	7.9	60
62						9.6	10.8	11.2	9.8	7.8	7.0	7.6	62
64							10.2	10.2	9.6	7.7	7.0	7.5	64
66							8.2	9.6	9.5	7.5	6.8	7.2	66
68							7.7	9.1	9.1	7.4	6.5	7.1	68
70							7.3	8.6	8.2	7.2	6.2	6.8	70
72								6.4	6.5	7.1	5.9	6.7	72
74								6.1	6.1	7	5.6	6.5	74
76								5.8	5.8	6.6	5.3	6.4	76
78									3.6	6.3	4.8	6.3	78
80									3.4	5.8	4.5	6	80
82										5.4	4.3	5.7	82
84										3.9	4.1	5.6	84
86										3.7	4	5.3	86
88										3.4	2.9	3	88
90											2.7	2.9	90
92													92
94													94

Load Chart - Telescopic Boom + Luffing Jib + Superlift Device (TSL)

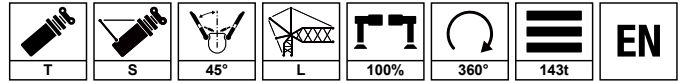

Unit: t

Jib m	52.6m												Jib m
	18m	24m	30m	36m	42m	48m	54m	60m	66m	72m	78m	84m	
14													14
16	49.8												16
18	46.7	40.3											18
20	44.6	39.7	33.2										20
22	43.9	39.4	31.8	28.1									22
24	42.7	38.8	31.2	28.1	24.5								24
26	42.0	38.2	30.6	28.1	24.5	22.3							26
28	39.9	38.8	30.1	27.2	24.5	21.5	19.1						28
30	36.6	36.1	30.5	26.3	23.5	20.6	18.6	16.4					30
32		33.3	29.4	27.7	23.1	20.4	17.7	16.2	12.1				32
34		30.9	28.2	27.1	22.5	20.0	17.0	15.1	11.6	9.2			34
36		28.7	27.1	25.9	22.2	19.5	16.4	14.7	11.3	9.0	8.3		36
38		26.8	26.1	25.4	21.6	19.4	15.4	14.4	10.9	8.8	8.1	7.1	38
40		16.7	24.7	24.0	20.8	19.2	15.8	13.9	10.6	8.6	7.9	7.1	40
42		14.8	23.2	22.8	19.7	19.1	15.3	13.7	10.3	8.3	7.7	7.1	42
44			16.7	21.3	18.7	18.6	15.1	13.2	10.0	8.1	7.4	7.1	44
46			15.7	20.2	17.9	18.0	14.8	12.7	9.8	7.8	7.1	7.1	46
48			14.9	18.9	17.2	17.3	14.5	12.2	9.6	7.7	7.0	7.1	48
50				13.5	14.9	16.6	13.9	12.1	9.6	7.7	6.9	7.1	50
52				12.8	14.9	16.0	13.3	12.0	9.6	7.7	6.8	7.0	52
54				12.1	11.7	15.3	12.7	11.8	9.6	7.7	6.6	6.8	54
56					11.1	14.5	12.1	11.6	9.5	7.7	6.6	6.4	56
58					10.5	10.1	11.8	11.5	9.1	7.7	6.4	6.2	58
60						9.6	11.4	11.4	8.6	7.6	6.2	6.0	60
62						9.1	10.8	10.9	8.1	7.5	6.1	5.8	62
64						8.7	10.2	9.8	7.9	7.3	5.8	5.6	64
66						8.2	9.7	9.6	7.8	7.2	5.8	5.5	66
68							7.3	9.0	7.7	7.0	5.6	5.3	68
70							6.9	8.5	7.4	6.9	5.4	5.1	70
72							6.5	6	6.8	6.7	4.9	5	72
74								5.7	5.7	6.6	4.7	4.9	74
76								5.4	5.3	6.5	4.4	4.8	76
78									5	6.1	4.2	4.6	78
80									3.2	5.8	4	4.3	80
82									3	5.4	3.4	4.2	82
84										4.9	3.3	4	84
86										3.3	3.2	2.3	86
88										3	3.1	2.2	88
90											2.3	2.1	90
92											2	2.1	92
94											1.9		94



SANY GROUP CRANE BU

SANY Mobile Crane Industrial Park, No.168 Jinzhou Avenue, Jinzhou Development Zone, Changsha City,
Hunan Province, P.R. China Zip 410600
Consulting sanycrane@sanygroup.com (Crane BU) / crd@sany.com.cn (IHQ)
After-sales Service 0086-400 6098 318

Reminder:

Any change in the technical parameters and configuration due to product modification or upgrade may occur without prior notice.
The machine in the picture may include additional equipment. This brochure is for reference only, and goods in kind shall prevail.
Copyright at SANY. No part of this brochure may be copied or used for any purpose without written approval from SANY.

© Edited in January 2024

