



SCC350TB

Telescopic Boom Crawler Crane 35 Tons Lifting Capacity

Quality Changes the World



Max. lifting moment: 117.5t·m
Max. boom length: 31.5m
Max. boom + jib length: 31.5m+13.7m

The parameters and diagrams in the brochure is only for reference, which is subject to further update in real machine.

■ www.sany.com.cn



Telescopic Boom Crawler Crane SCC350TB

P03

Main characteristics

- Product Specification
- Safety Device

P08

Technical parameters

- Major Performance & Specifications
- Outline Dimension
- Transport Dimension
- Transport Plan

P14

Cofigurations

- Working range of H
- Load Chart of H
- Load Chart of FJ



SCC350TB
TELESCOPIC BOOM CRAWLER CRANE
35 TONS LIFTING CAPACITY

QUALITY CHANGES THE WORLD

Main Characteristics

- Page 04 Product Specification
- Page 06 Safety Devices

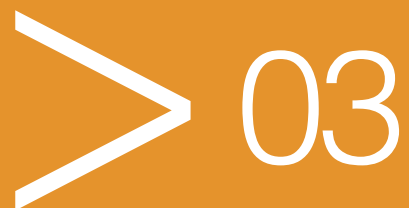

Product Specification



Engine

- Model: ISUZU 4HK1XKSC diesel engine;
- Type: four-stroke, water cooling, straight 4-cylinder, direct injection, turbo supercharging, inter-cooling. Meet Off-highway Emission Regulation of Europe (Tier III), and comply with Off-highway Emission Regulation of China (Tier III);
- Displacement: 5.19L;
- Rated power: 133kW/2000rpm;
- Maximum torque: 657N · m/1500rpm;
- Starting device: 24V-5.0kW;
- Radiator: aluminium sheet fin type radiator core;
- Air filter: dry type air filter system, fitted with main filter element, safety filter element and resistance indicator;
- Hand throttle: gear type hand throttle, electric;
- Fuel filter: replaceable paper filter element;
- Batter: two 12Vx180Ah capacity batteries, connected in series;
- Fuel tank: 400L.

Electrical Control System

- Adopt SYIC-II integrated control system independently researched and developed by Sany. This system is featured by high integration level, accurate operation and reliable quality;
- Control system: composed of power system, engine system, main control system, Load Moment Limiter, auxiliary system and safety monitoring system. Data communication among controller, display and engine is conducted by CAN bus technology;
- Display: It can display the engine rotating speed, fuel volume, engine oil pressure, servo pressure, engine working time, load weight, boom angle and other working parameters and working conditions.

Hydraulic System

- Main pump: adopt open piston pump with large variable displacement, providing oil supply to the main actuator;
- Gear pump: dual gear pump for swing, and control circuit;
- Control: the main pump adopts the control type of electrically proportionate positive flow, and the winch motor is piston motor with variable displacement. The operating components are two hydraulically-controlled cross handles, one hydraulic control pedal valve for boom telescoping, and one dual pedal control valve for travel, to control each actuator proportionally;
- Max. pressure of system:
Main load, aux. load, and travel system: 32MPa;
Boom hoist cylinder lifting: 32MPa;
Swing system: 20MPa;
Control system: 5MPa;
- Hydraulic oil tank capacity: 550L.

Main and aux. load hoist mechanism

- Pump and motor: energy-efficient, combination of winch balance valve and anti-hook sliding technology, lifting or lowering the load steadily;
- Winch brake adopts wet type and spring loaded fin type normally engaged brake, spring force braking, oil pressure released;
- Main and aux. load hoist winches adopt piston motor of fixed displacement to drive planetary reducer.

Main lifting mechanism	Rope speed (outermost layer)	0~135m/min
	Diameter of wire rope	Φ16mm
	Overall length of wire rope	165m
	Rated tensile force of single rope	5.3t
Auxiliary lifting mechanism	Rope speed (outermost layer)	0~135m/min
	Diameter of wire rope	Φ16mm
	Overall length of wire rope	135m
	Rated tensile force of single rope	5.3t

Boom hoist mechanism

- Double acting single piston rod hydraulic cylinder, fitted with safety balance valve, luffing angle: -2°~78°, adopting dead-weight luffing system to reduce the energy consumption and improve the steadiness of luffing operation.

Swing mechanism

- Swing brake adopts wet type and spring loaded fin type normally engaged brake, spring force braking;
- With integrated cushion valve, the swing system has free slip function to realize steady swing start and control, showing outstanding microinching performance;
- Unique swing cushion design ensures more stable braking;
- Swing drive: external gearing swing drive, capable of conducting 360° rotation, maximum rotation speed 2r/min. The maximum driving pressure can reach 20MPa;
- Swing lockout: locking device, to ensure that the superstructure can be locked in front and rear directions conveniently and reliably during off-work time and transportation;
- Swing bearing: single row ball type bearing.



Product Specification

Counterweight

- Block-type counterweight is easy to assemble and disassemble. The self-assembly function is realized for easier transportation;
- The counterweight tray and blocks are stacked in a way that is easy to assemble, disassemble and transport;
- Rear counterweight: gross weight 9.5t;
- Provide load chart of no counterweight.

Superstructure

- High strength steel welding frame structure, no torsional deformation, reasonable component layout, and convenient maintenance service.

Cab and Control

- Novelty in cab design, artistic modeling and trim and large area glass window with a tilt angle of 20° to broaden horizon; fitted with low beam headlamp and rearview mirror to broaden horizon; installed with air conditioner and radio; the arrangement of seats, control handle and various control buttons is ergonomically designed to enable more conformable operation;
- Cab layout: Integrated touch screen of large dimension, vibration handles are offered as optional and man-machine interaction interface are more perfect;
- Armrest box: operation handle, electrical switch, emergency stop switch and ignition switch are installed on the left and right armrest boxes. The armrest box can be adjusted with the seat;
- Seat: suspension type multi-mode multi-level regulated seat, fitted with unloading switch;
- Air conditioner: cooling and heating air, optimized air passage and air port;
- Multiple cameras can be presented on the monitor at the same time to realize real-time monitoring of wire rope on each winch, conditions behind the counterweight and surrounding the machine.

Traveling drive

- Independent traveling drive device is adopted for each side of crawler frame, so as to realize straight travel, turning through reducer and drive wheel by travel motor. And the machine is capable of cab auto direction aligning;
- Traveling speed: The traveling can be switched between high speed and low speed, and the high speed can be up to 3km/h;
- Gradeability: 45%.

Traveling braking

- Concealed wet type and spring loaded fin type normally engaged brake, spring force braking, oil pressure released.

Telescopic crawler

- The extension and retraction of crawler frames are realized through cylinder. The crawlers are extended at work and retracted for transport with the whole basic machine;
- The crawlers can work in fully extended and fully retracted conditions, and respective hierarchical load chart is provided.

Crawler tensioning

- Spring tensioner with auxiliary hydraulic cylinder regulates the tension degree through charging grease, and the spring can perform buffer and protection function when traveling.

Steering system

- It can realize single track turning and pivot turning.

Track shoe

- Excavator three-reinforcement chain link track shoe is adopted, which is made of high strength alloy cast steel, has stronger road holding capacity and longer service life, and can adapt to various harsh road conditions.. Width 700mm, Qty 56x2.

Track roller

- Maintenance-free track roller.

Product Specification



Main boom

- The boom is made of high-strength steel structure with U-shape section area, with five sections, of which the basic boom is 10m and the max. boom length is 31.5m;
- Single cylinder and rope row for telescoping.

Fixed jib

- TwoFJ configurations: 7.9m and 13.7m respectively;
- Installation angle includes 0°, 15° and 30°.

Boom tip pulley

- Welding structure, connected with the boom through pin, and used for auxiliary hook operation.

Lifting hook

Name	Capacity (t)	Pulley block	Weight (t)	Quantity
1	35	4	0.32	1
2	5.9	1	0.16	1

Note: the above-mentioned operating equipment is full-up configuration. The actual configurations are subject to contract.

Safety Device



Smart Integrated Load Moment Indicator

- The integrated LMI system is provided as standard offering to realize calibration-free and high safety and efficiency for equipment control to realize calibration-free and high safety and efficiency for equipment control;
- The LMI system can automatically detect the suspended load weight, working radius of the crane and the angle of boom, and compare rated load weight and actual load, working radius and boom angle. Under normal operation condition, it can intelligently judge and automatically cut off the crane action in dangerous direction, and have black box function to record the overload information;
- Its main components include: monitor, controller, length and angle sensor, pressure sensor, etc.

Assembly/working mode switching switch

- In Assembly Mode, certain safety devices are disabled to facilitate crane assembly;
- In Work Mode, all safety limiting devices activate to protect the operation.

Emergency Stop

- In emergency situation, this button is pressed down to cut off the power supply of the whole machine and all actions stop.

Over-hoist Protection of the Main/Auxiliary Load Hoist

- Height limiter is equipped on the boom/jib tip, which prevents the hook lifting up too much. When the hook is lifted up to the limit height, the limit switch activates, alarm pops up on the monitor, buzzer on the right front control panel sends alarm, failure indicator light starts to flash and the hook hoisting action is cut off automatically.

Over-release Protection of the Main/Auxiliary Load Hoist

- Three-wrap protector is installed on main and aux. load hoist to prevent over-release of wire rope. When the rope is paid out close to the last three wraps, the limit switch acts, and the system sends alarm through buzzer and show the alarm on the monitor, automatically cutting off the winch action.



Safety Device

Function Lock

- If the function lock level is not in work position, all the other handles won't work, which prevents any mis-operation caused by accidental hitting.

Slewing Lock

- Electrical lock is provided, which needs to be released for swing to work, so as to prevent operator accidentally hit the handle and ensure the safety;
- Cylinder lock can lock the upperworks at two directions.

Hook Latch

- The lifting hook is installed with a baffle plate to prevent wire rope from falling off.

GPS Monitoring System

- Standard remote monitoring system: It can provide functions like GPS locating, GPRS data transfer, machine status inquiry and statistics, operating data monitoring and analysis, and remote diagnosis of failures.

Tri-color Load Indicator

- The load indicator light has three colors, i.e., green, yellow and red; and the real time load status is presented on the display. When the actual load is smaller than 90% of rated load, the green light is on; when the actual load is larger than 90% and smaller than 100%, the yellow light is on, the alarm light flashes and sends out intermittent sirens; when the actual load reaches 100% of rated load, the red light is on, the alarm light flashes and sends out continuous sirens. When the actual load reaches 102%, the system will automatically cut off the crane's dangerous operation.

Flash Alarm

- When the LMI is powered on, the flash alarm will turn on.

Swing Indicator Light

- The swing indicator light flashes during traveling or swing.

Seat Interlock

- If the operator leaves the seat, all control handles and switches will be disabled immediately to prevent any mis-operation due to accidental collision.

Illuminating Light

- The machine is equipped with short-beam light in front of machine, lamps in operator's cab and lighting devices for night operation, as well as boom lights, so as to increase the visibility during work.

Rearview Mirror

- It is installed on the left of the operator's cab and at the front handrail of the sheet metal for monitoring the rear part of the machine.

Level Indicator

- Electrical level indicator can show the inclination angle of superstructure on the monitor.

Closed Circuit Monitoring System

- There are two cameras on the tail of rotating bed, which can show the rear part and winches working on the machine.



SCC350TB
TELESCOPIC BOOM CRAWLER CRANE
35 TONS LIFTING CAPACITY

QUALITY CHANGES THE WORLD

Technical Parameters

- Page 09 Major Performance & Specifications
- Page 10 Outline Dimension
- Page 11 Transport Dimension
- Page 13 Transport Plan



Major Performance & Specifications

Major Performance & Specifications of SCC350TB			
Specification		Unit	Parameter
Outline dimension	Full length of the whole crane	mm	12600
	Width of the whole machine (retracted)	mm	4600 (2990)
	Height of the whole machine	mm	3250
	Center distance of driving and engaged wheels	mm	4890
	Width of track shoe	mm	700
H (main boom) configuration	Maximum rated lifting weight	t	35
	Main boom length	m	10~31.5
	Main boom angle	°	-2°~78°
	Maximum rated lifting moment	t·m	117.5
FJ(fixed jib) configuration	Longest main boom + longest jib	m	31.5+13.7
	Included angle between main boom and jib	°	0°, 15°, 30°
Working speed	Main/aux. load hoist rope speed	m/min	0~135
	Time to fully boom up/down	s	48/44
	Time to fully extend/retract boom	s	55/39
	Slewing speed	rpm	0~2
	No-load traveling speed	km/h	0~3.0
Engine	Model		ISUZU 4HK1XKSC
	Rated power	kW/rpm	133/2000
Wire rope	Diameter	mm	Φ 16
Transportation parameters	Weight of the whole machine	t	43
	Maximum weight of single piece transportation	t	32 (Remove counterweight, jib, main hook and auxiliary hook)
	Transportation dimension (long x width x height)	mm	12600x2990x3250
Other Parameters	Average ground bearing pressure	MPa	0.07
	Min. swing radius	mm	3660

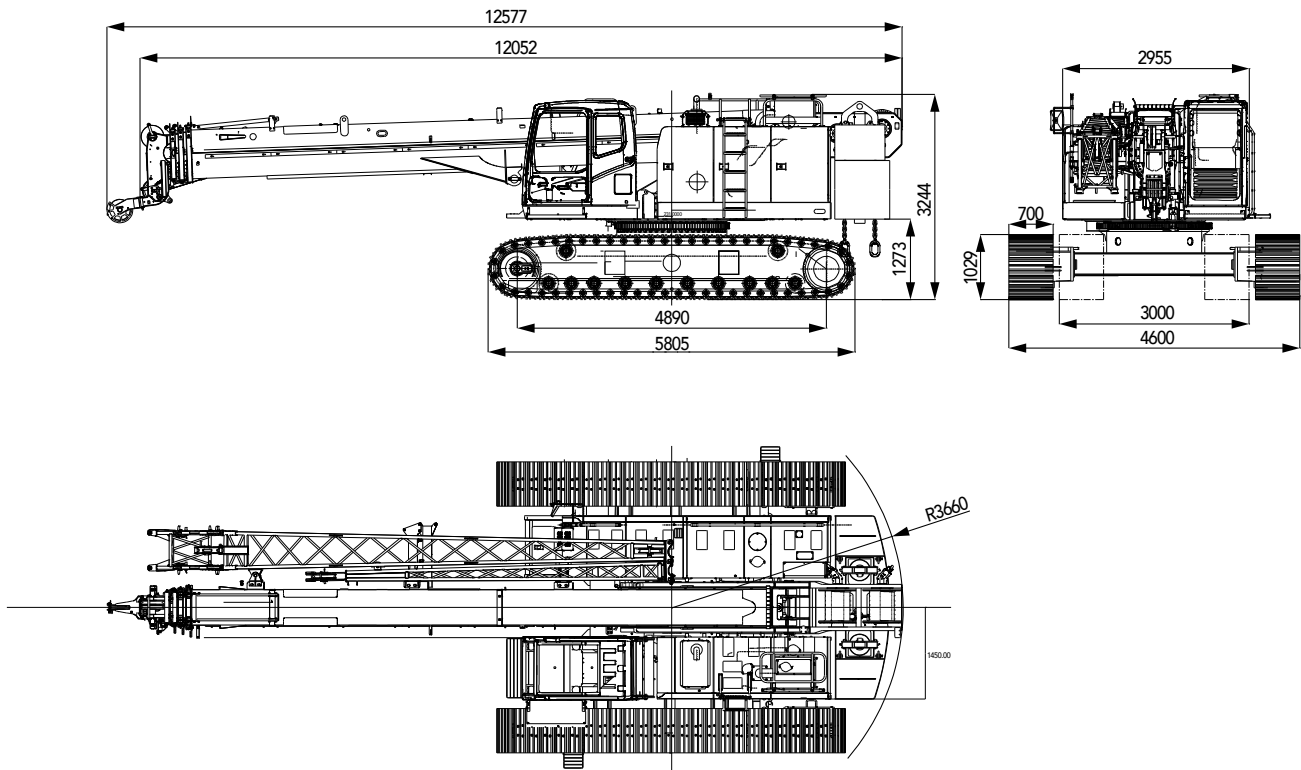
Outline Dimension

Transport Dimension

Note:

- ① . The component transportation dimension is schematic diagram, and is not drawn to scale. The marked dimension is design value, excluding the package.
- ② . The weight is design value, which may be slightly different because of manufacturing tolerance. The total weight of counterweight is 9.5t.
- ③ . After product upgrading of the Company, the outline dimension and weight of the components above may vary, and the new product shall prevail.

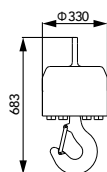
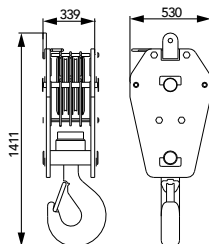
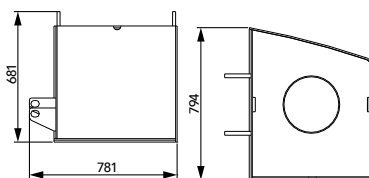
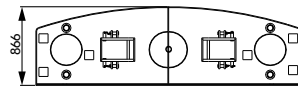
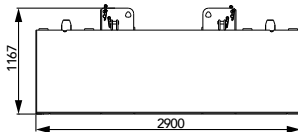
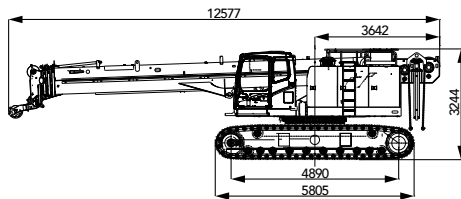
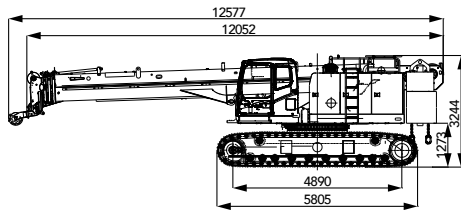

Whole machine ×1

Length (L)	12.58m
Width (W)	3.00m
Height (H)	3.30m
Weight	43t

Basic machine (without counterweight, jib and lifting hook) ×1

Length (L)	12.58m
Width (W)	3.00m
Height (H)	3.25m
Weight	32t

Counterweight tray ×1

Length (L)	2.9m
Width (W)	0.87m
Height (H)	1.17m
Weight	7.3t

Rear counterweight ×2

Length (L)	0.78m
Width (W)	0.79m
Height (H)	0.68m
Weight	1.1t

35t lifting hook ×1

Length (L)	0.53m
Width (W)	0.34m
Height (H)	1.41m
Weight	0.32t

5.9t lifting hook ×1

Length (L)	0.33m
Width (W)	0.33m
Height (H)	0.68m
Weight	0.16t

Transport Dimension

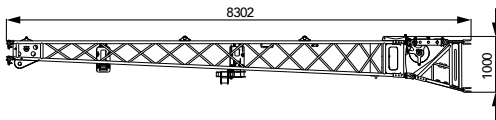

7.9m jib

×1

Length (L)	8.30m
Width (W)	1.02m
Height (H)	1.00m
Weight	0.63t

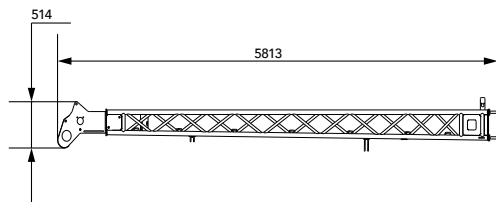

5.8m jib

×1

Length (L)	5.81m
Width (W)	0.38m
Height (H)	0.51m
Weight	0.21t

Transport Plan

- Transportation mode I: whole machine transportation, gross weight 43t, 12.6m x 2.99m x 3.25m (L x W x H)

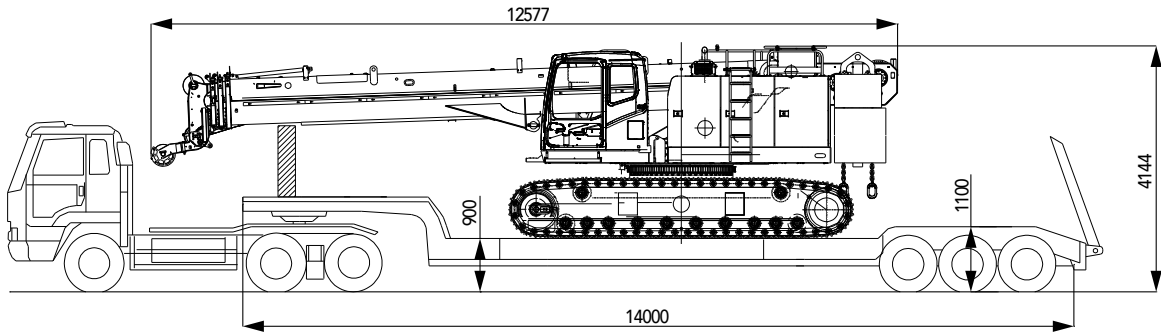

- Transportation mode II: dismantle the counterweight, jib and lifting hook, transport through two vehicles with maximum weight of single piece transportation 32t and 12.6m x 2.99m x 3.25m (L x W x H)

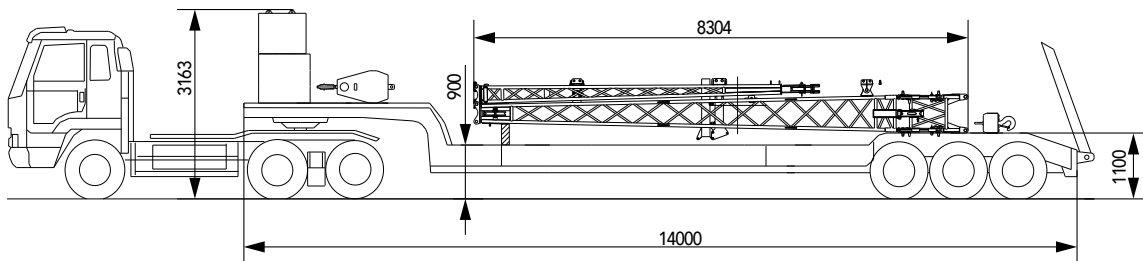
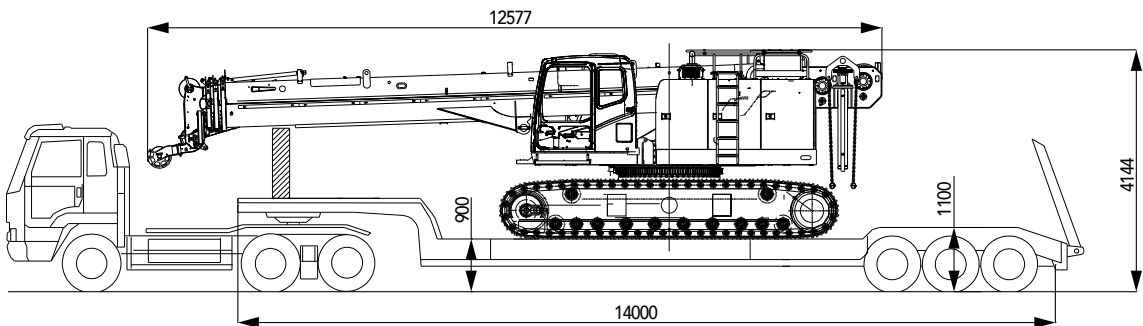



SCC350TB
TELESCOPIC BOOM CRAWLER CRANE
35 TONS LIFTING CAPACITY

QUALITY CHANGES THE WORLD

Cofigurations

- Page 15 Working range of H
- Page 16 Load Chart of H
- Page 18 Load Chart of FJ

> 14

Working range of H

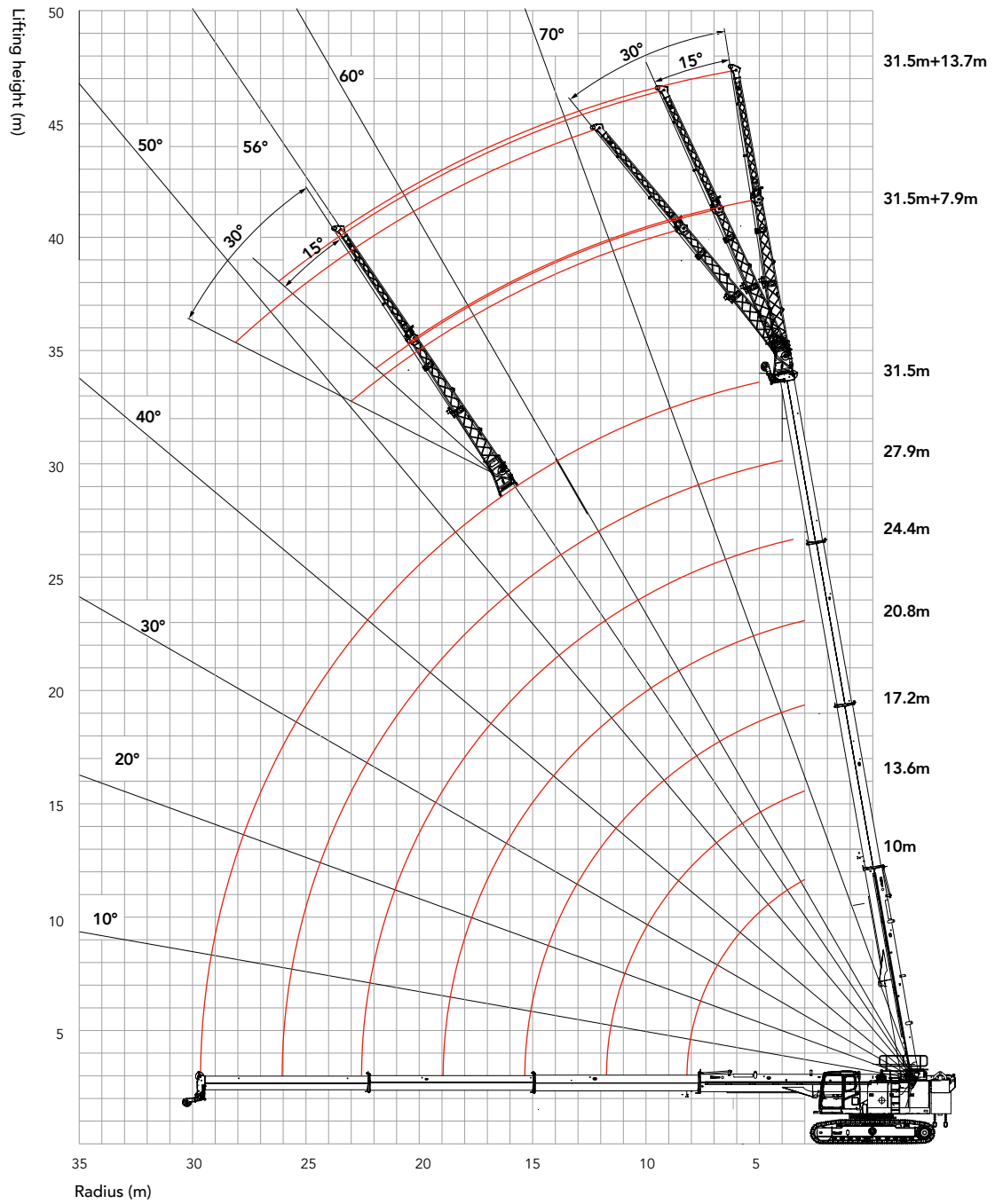

Load Chart of H

SCC350TB Telescopic Boom Crawler Crane-H 1/2															
Counterweight 9.5t															
Radius (m)	10		13.6		17.2		20.8		24.4		27.9		31.5		Radius (m)
	Wide gauge 3.9m	Narrow gauge 2.3m	Wide gauge 3.9m	Narrow gauge 2.3m	Wide gauge 3.9m	Narrow gauge 2.3m	Wide gauge 3.9m	Narrow gauge 2.3m	Wide gauge 3.9m	Narrow gauge 2.3m	Wide gauge 3.9m	Narrow gauge 2.3m	Wide gauge 3.9m	Narrow gauge 2.3m	
3	35	29.5	22.9	22.9	22.9	22.9									3
3.5	32	24.5	22.9	22.9	22.9	21.4	19.5	19.5							3.5
4	28	20.8	22.9	19.7	21.8	18.6	18.6	17.6	15	15					4
4.5	25.6	17.7	22.3	17.2	20.4	16.4	17.5	15.6	14	14					4.5
5	23.5	15	20.9	15.2	19.2	14.5	16.4	13.9	13.3	13.3	11.1	11.1			5
5.5	21.3	12.9	19.6	13.5	18	13	15.3	12.5	12.6	12	10.7	10.7	9	9	5.5
6	19.5	11.2	18.7	11.8	17	11.8	14.6	11.4	11.9	11	10.2	10.2	8.6	8.6	6
6.5	17.3	9.9	17.8	10.5	16	10.7	13.7	10.4	11.4	10.1	9.9	9.7	8.3	8.3	6.5
7	15.2	8.8	15.9	9.3	15	9.6	13.1	9.5	10.8	9.2	9.4	9	7.9	7.9	7
7.5	13.5	7.8	14.2	8.4	14.6	8.7	12.4	8.8	10.2	8.5	9	8.3	7.7	7.7	7.5
8	12.1	7	12.8	7.6	13.2	7.9	11.5	8.1	9.7	7.9	8.7	7.7	7.4	7.4	8
9			10.6	6.3	10.9	6.6	10.9	6.8	9	6.9	8	6.7	7	6.5	9
10			8.9	5.2	9.3	5.6	9.5	5.7	8.4	5.9	7.5	5.9	6.4	5.7	10
11			7.6	4.4	8	4.7	8.2	4.9	7.8	5.1	7.1	5.1	6	5.1	11
12					6.9	4.1	7.1	4.3	7.3	4.4	6.5	4.5	5.7	4.5	12
13					6.1	3.5	6.3	3.7	6.4	3.8	6.1	3.9	5.4	4	13
14					5.4	3	5.6	3.2	5.7	3.4	5.7	3.5	5	3.5	14
16							4.4	2.5	4.6	2.6	4.7	2.7	4.6	2.8	16
18							3.6	1.9	3.7	2	3.8	2.1	3.9	2.2	18
20									3.1	1.6	3.2	1.7	3.2	1.8	20
22											2.6	1.3	2.7	1.4	22
24											2.2	1	2.3	1.1	24
26													1.9	0.8	26
28													1.6	0.6	28
30															30
parts of line	7		5		5		4		4		3		2		parts of line
2	0		16.7		33.3		50		67.7		83.3		100		2
3	0		16.7		33.3		50		67.7		83.3		100		3
4	0		16.7		33.3		50		67.7		83.3		100		4

Unit: t

Load Chart of H

SCC350TB Telescopic Boom Crawler Crane-H 2/2															
Counterweight 0t															Radius (m)
Radius (m)	10		13.6		17.2		20.8		24.4		27.9		31.5		Radius (m)
	Wide gauge 3.9m	Narrow gauge 2.3m	Wide gauge 3.9m	Narrow gauge 2.3m	Wide gauge 3.9m	Narrow gauge 2.3m	Wide gauge 3.9m	Narrow gauge 2.3m	Wide gauge 3.9m	Narrow gauge 2.3m	Wide gauge 3.9m	Narrow gauge 2.3m	Wide gauge 3.9m	Narrow gauge 2.3m	
3	35	15.3	22.9	14.3	22.9	13.3									3
3.5	27.8	12.4	22.9	11.9	22.9	11.2	19.5	10.5							3.5
4	22.5	10.3	21	10	19.5	9.5	18.2	9	15	8.6					4
4.5	18.8	8.7	17.8	8.6	16.7	8.2	15.7	7.9	14	7.5					4.5
5	15.8	7.4	15.3	7.4	14.5	7.2	13.8	6.9	13.1	6.6	11.1	6.4			5
5.5	13.1	6.2	13.3	6.4	12.8	6.3	12.2	6.1	11.7	5.9	10.7	5.7	9	5.5	5.5
6	11.1	5.2	11.8	5.7	11.4	5.6	10.9	5.5	10.5	5.3	10.1	5.1	8.6	4.9	6
6.5	9.6	4.4	10.2	5	10.2	5	9.8	4.9	9.5	4.8	9.1	4.6	8.3	4.4	6.5
7	8.3	3.8	8.9	4.3	9.2	4.4	8.9	4.4	8.6	4.3	8.3	4.2	7.9	4	7
7.5	7.2	3.2	7.9	3.8	8.2	4	8.1	4	7.9	3.9	7.6	3.8	7.4	3.7	7.5
8	6.3	2.7	7	3.3	7.4	3.6	7.4	3.6	7.2	3.5	7	3.4	6.8	3.3	8
9			5.6	2.5	6	2.8	6.2	2.9	6.1	2.9	6	2.8	5.8	2.8	9
10			4.6	1.9	4.9	2.2	5.1	2.4	5.3	2.4	5.2	2.4	5.1	2.3	10
11			3.8	1.4	4.1	1.8	4.3	1.9	4.5	2	4.5	2	4.4	1.9	11
12					3.5	1.4	3.7	1.6	3.8	1.6	3.9	1.6	3.9	1.6	12
13					2.9	1	3.1	1.2	3.3	1.3	3.3	1.3	3.4	1.3	13
14					2.5	0.8	2.7	1	2.8	1.1	2.9	1.1	3	1.1	14
16							2		2.1	0.6	2.2	0.7	2.3	0.7	16
18							1.4		1.6		1.6		1.7		18
20									1.1		1.2		1.3		20
22											0.9		1		22
24											0.6		0.7		24
26													0.5		26
28															28
30															30
parts of line	7		5		5		4		4		3		2		parts of line
2	0		16.7		33.3		50		67.7		83.3		100		2
3	0		16.7		33.3		50		67.7		83.3		100		3
4	0		16.7		33.3		50		67.7		83.3		100		4

Load Chart of FJ

SCC350TB Telescopic Boom Crawler Crane-FJ							
Working angle	31.5+7.9			31.5+13.7			Working angle
	Installation angle of jib			Installation angle of jib			
	0°	15°	30°	0°	15°	30°	
78°	3500	2150	1650	2250	1250	900	78°
77°	3300	2100	1600	2150	1200	900	77°
75°	3100	2000	1550	1950	1150	850	75°
73°	2800	1900	1500	1750	1100	800	73°
71°	2600	1800	1400	1600	1050	750	71°
68°	2300	1650	1250	1450	1000	700	68°
66°	2100	1550	1150	1350	950	660	66°
63°	1800	1350	1000	1150	850	600	63°
61°	1500	1200	850	1050	750	550	61°
58°	1100	950	650	650	600	500	58°
56°	700	650	500	500			56°
Minimum elevation angle	32°	34°	35°	34°	37°	39°	Minimum elevation angle

※ Note-Rate load of crane:

- ① . The rated capacity in the load charts are calculated when the crane is parking on firm and level ground less than 1% gradient, and lifting the load slowly and steadily;
- ② . The rated capacity values in the load charts are obtained when the wind speed is lower than 9.8 m/s under 75% of tipping load;
- ③ . The gray-shaded values in boom load chart are determined by boom strength, and the rest of values are determined by stability; the values in FJ load chart are determined by boom strength;
- ④ . All values in the load charts are valid for 360° slewing.
- ⑤ . The rated load shall be no more than 4.1t when upper boom point sheave. If the jib unfolds, the rated lifting capacity of boom is 2t less.
- ⑥ . The rated capacity in the load charts include the weight of lifting hook,(main hook 0.36t, jib hook 0.16t) etc.; therefore, the actual rated capacity is the value after deducting the weight of lifting tools (such as hook, riggings and wire rope), from the rated load in the load charts.
- ⑦ . If the boom/jib length or angle falls between two lengths given in the table, the larger one shall be taken to refer the lifting capacity;
- ⑧ . Rear counterweight 9.5t for the machine;
- ⑨ . The max. allowable out-of-level ground is 4° . Refer to the operation manual for detailed load charts based on out-of-level degrees.



Zhejiang SANY Equipment Co., Ltd.

SANY Industrial Park, No. 2087 Daishan Road, Wuxing District, Huzhou City,
Zhejiang Province, P. R. of China Zip 313028
After-sales Service 400 887 8318
Consulting 400 887 9318

— Agent information —

Due to updated technology, the technical parameters and configurations are subject to change without prior notice. The machine in the picture may include additional equipment. This album is for reference only, subject to the object.
All rights reserved for Sany, without the written permission of Sany, the contents of any part of this content shall not be copied or copied for any purpose.

© Printed in December 2019 in China

www.sany.com.cn



Please scan the official WeChat account of Sany for more information.